

Structural Connections
Reinforcing Bar Couplers

Leviat[®]

Reinforcing Bar Couplers



Australian Edition

Imagine. Model. Make.

Leviat®

A CRH COMPANY

We imagine, model and make engineered products and innovative construction solutions that help turn architectural visions into reality and enable our construction partners to build better, safer, stronger and faster.

Leviat is a world leader in connecting, fixing, lifting and anchoring technology.

From the build of new schools, hospitals, homes and infrastructure, to the repair and maintenance of heritage structures, our engineering skills are making a difference around the world.

We provide technical design assistance at every stage of a project, from initial planning to installation and beyond.

Our technical support services range from simple product selection through to the development of a fully customised project-specific design solution.

Every promise we make locally, has the commitment and dedication of our global team behind it. We employ almost 3,000 people at 60 locations across North America, Europe and Asia-Pacific, providing an agile and responsive service worldwide.

Leviat, a CRH company, is part of the world's leading building materials business.





>3,000
People

60+
Locations

~20
Countries

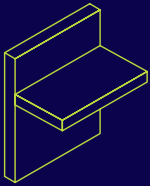

Structural Connections

Systems to form robust, efficient connections, and continuity of concrete reinforcement as necessary, between walls, slabs, columns, beams and balconies, providing structural integrity as well as enhanced thermal and acoustic performance.

- Insulated balcony connectors
- Reinforcing bar couplers
- Concrete Connections
- Reinforcement continuity systems
- Punching shear reinforcement
- Shear load connectors
- Floor Joint Systems
- Precast / Reinforced Columns
- Infrastructure Products
- Precast Connections
- Acoustic dowels and bearings
- Prestress

Other areas of expertise:

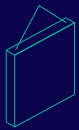

Lifting & Bracing

Systems for the safe and efficient transportation, lifting and temporary bracing of cast concrete elements and tilt-up panels before permanent structural connections are made.



Façade Support & Restraint

Systems for the safe and thermally-efficient fixing of the external building envelope, including brick and natural stone, insulated sandwich panels, curtain walling and suspended concrete façades, and also the repair and strengthening of existing masonry installations.

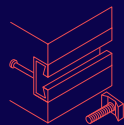

Anchoring & Fixing

Systems for fixing secondary fixtures to concrete, including anchor channels, bolts and inserts; also tension rod systems for roofs and canopies.



Formwork & Site Accessories

Non-structural accessories that complement our engineered solutions and help keep your construction environment operating safely and efficiently, including moulds for casting standard and special concrete elements and construction essentials such as reinforcing bar spacers.

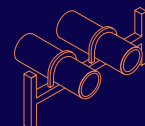

Industrial Technology

Mounting channels, pipe clamps and other versatile framing systems that provide safe fixing in a wide range of industrial applications.

Leviat product ranges:

Ancon | Aschwanden | Connolly | Halfen | Helifix | Isedio | Meadow Burke | Modersohn | Moment | Plaka | Scaldex | Thermomass

Reinforcing Bar Couplers

Contents

Coupler Selection	6-7
BT Couplers	8-14
BT Transition Couplers	12
BT Stainless Couplers	13
BT Weldable Couplers	14
BT Headed Anchors	15
MBT Couplers	16-17
MBT Transition Couplers	18-19
MBT Headed Anchors	20-21
MBT Electric Wrench	21
Other Ancon Products	21

Lapped joints are not always an appropriate means of connecting reinforcing bars. The use of laps can be time consuming in terms of design and installation and can lead to greater congestion within the concrete because of the increased amount of rebar used.

Ancon couplers can simplify the design and construction of reinforced concrete and reduce the amount of reinforcement required.

Lapped joints are dependent upon the concrete for load transfer. For this reason any degradation in the integrity of the concrete could significantly affect the performance of the joint.

The strength of a mechanical splice is independent of the concrete in which it is located and will retain its strength despite loss of cover as a result of impact damage or seismic event.

The Ancon range of reinforcing bar couplers is the most comprehensive available and includes parallel threaded and mechanically bolted couplers.

Ancon reinforcing bar couplers are available through major rebar stockists and approved distributors.



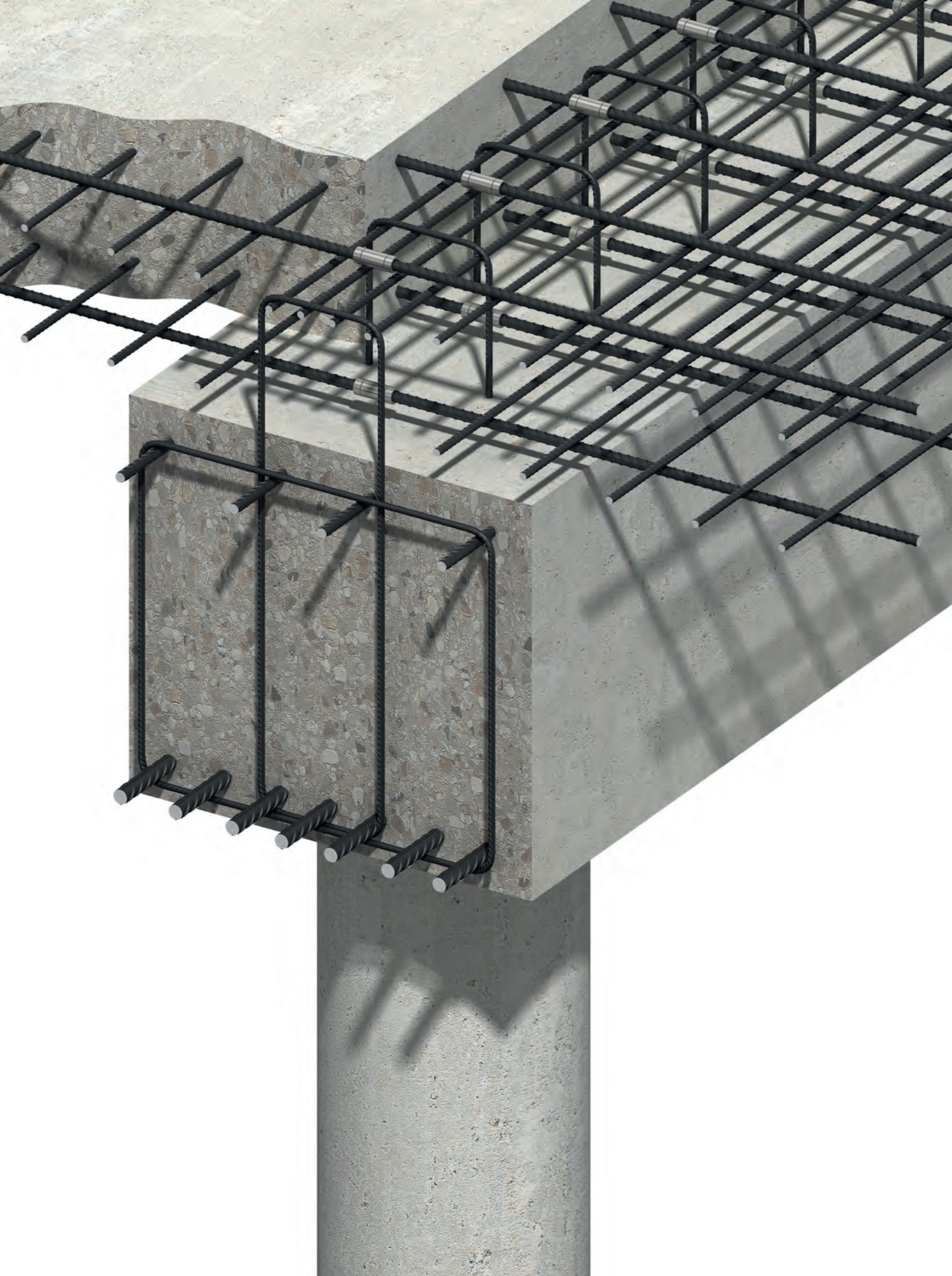

Reinforcing Bar Couplers

For many years the use of mechanical couplers to join reinforcing bars has been regarded as a means of reducing the use of long bars. Engineers and contractors now recognise the benefits of using couplers to accelerate the speed of construction, increase productivity and simplify design details.

Coupler Selection

The two types of Ancon reinforcing bar couplers require different fixing methods.

This, together with the quantity to be fixed and the location, will determine which is the most appropriate coupler for a particular situation.

Availability of Couplers

Bar Diameter (mm)	12	16	20	24	28	32	36	40	50
BT	✓	✓	✓	✓	✓	✓	✓	✓	✓
BT Headed Anchor	✓	✓	✓	✓	✓	✓	✓	✓	
BT Transition	✓	✓	✓	✓	✓	✓	✓	✓	✓
BT Stainless	✓	✓	✓	✓		✓		✓	
BT Weldable	✓	✓	✓	✓	✓	✓	✓	✓	
MBT	✓	✓	✓	✓	✓	✓	✓	✓	
MBT Transition	✓	✓	✓	✓		✓		✓	
MBT Headed Anchor	✓	✓	✓	✓	✓	✓	✓	✓	

Ancon couplers for 50mm reinforcing bar are manufactured on request.

BT Parallel Threaded Couplers

The BT system is one of the smallest and the most cost-effective coupler systems in our range, when used on large scale, high coupler volume projects. The ends of the bars are enlarged and a parallel thread is cut onto the ends to suit the threaded coupler. The coupler is assembled using a pipe or chain wrench. Calibrated wrenches are not necessary.



MBT Mechanically Bolted Couplers

MBT couplers are suitable where it is not convenient to have the bar ends prepared for the BT system. The bars are supported within the coupler on two serrated saddles. Bars are locked in place by a series of special lockshear bolts, the heads of which shear off when the predetermined tightening torque is reached, providing a visual check of correct installation.

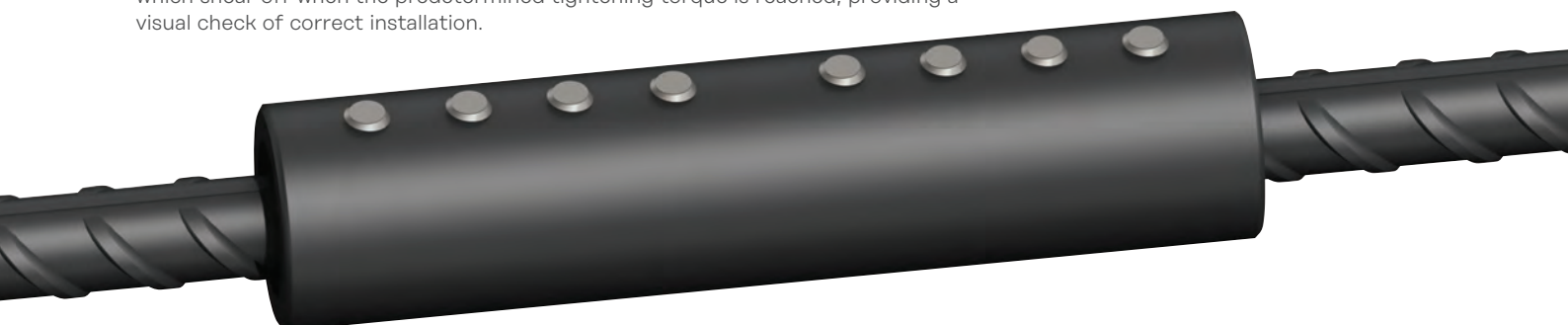

Coupler Range

Range	BT			BT Headed Anchor	MBT		
Type	Type A	Type B	Type C	BTAA	MBTXXC	Transition	HA
Bar Dia. (mm)	12-50	12-50	12-50	12-50	10-50	10-40	10-40
Bar End Prep	Threaded	Threaded	Threaded	Threaded	No	No	No
Bar Rotation Required	Yes	Limited	No	N/A	No	No	No
Installation Method	Wrench			Wrench	Wrench or Nut Runner		
Minimum Tensile Capacity	Full Strength up to 650MPa			Full Strength up to 650MPa	550 MPa		

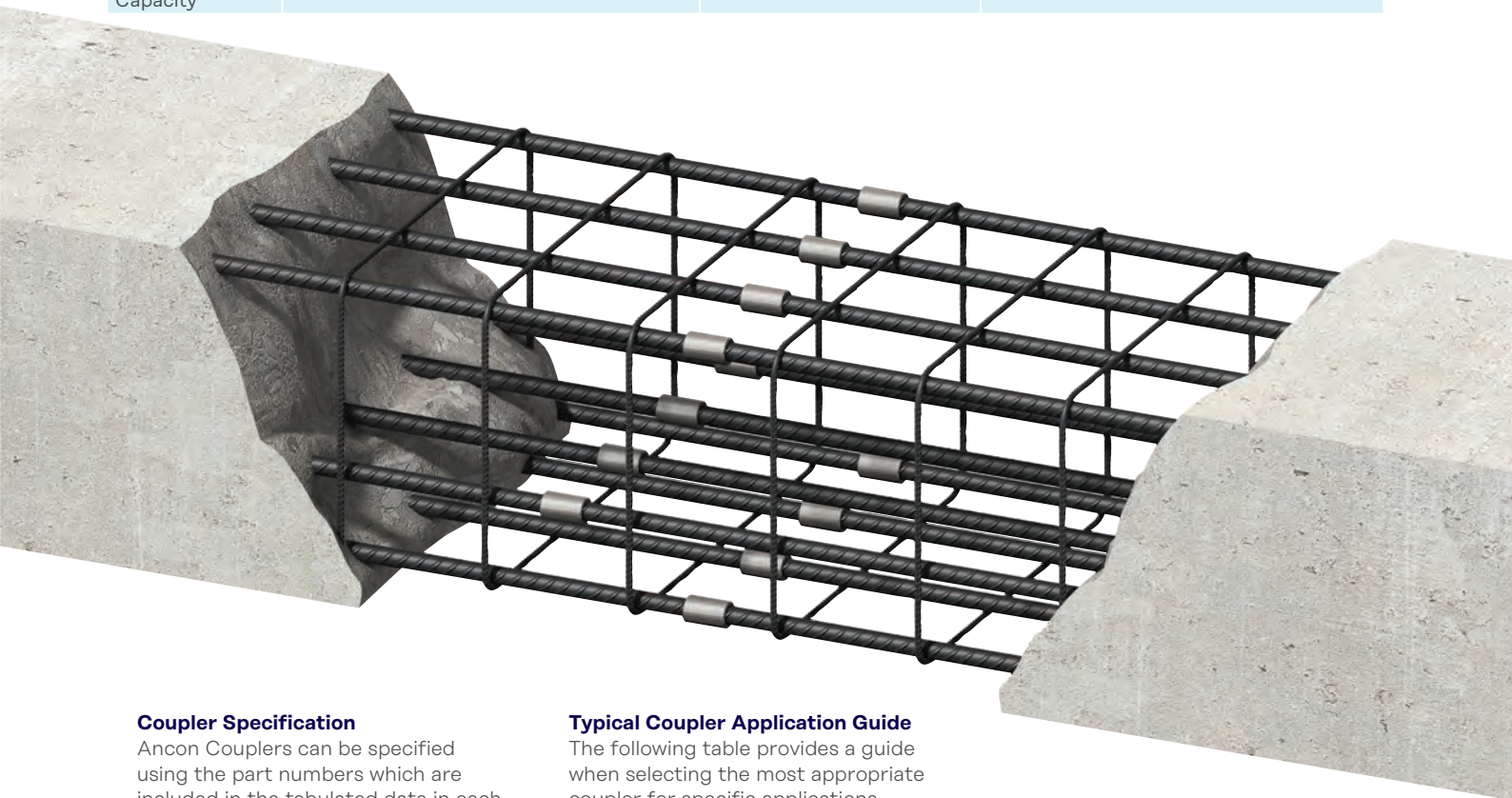

Coupler Specification

Ancon Couplers can be specified using the part numbers which are included in the tabulated data in each section of this brochure.

The following examples show how each type of connection should be specified when using 20mm bar.

Type of Connection	Reference
BT Type A	BT20/A
BT Type B	BT20/B
BT Type C	BT20/C
BT Headed Anchor	AA20
MBT Series	MBT20C
MBT Transition Series	MBT20/16C
MBT Headed Anchor	MBTHA20H

CAD drawings of Ancon couplers are available to download from www.ancon.com.au

Typical Coupler Application Guide

The following table provides a guide when selecting the most appropriate coupler for specific applications. Recommendations are based upon typical usage. For further assistance with coupler suitability and specification, please contact us.

Application	BT	MBT
Wall to slab connection	✓	
Wall to pre-cast beam connection	✓	
Column construction	✓	✓
Extension / repairs to existing structures		✓
Closing of access openings	✓	✓
Rebar cage pre-fabrication		✓
Hook bars to pile connection	✓	✓
Fatigue applications	✓*	✓*
Bar end terminations	✓	✓

* Project specific testing required. Contact us for further details.

Reinforcing Bar Couplers

BT Parallel Threaded Couplers

BT couplers produce a full strength joint yet they are among the smallest in the Ancon range, best suited to large scale projects requiring a high volume of couplers.

The end of each bar to be joined is cut square and enlarged by cold forging. This increases the core diameter of the bar to ensure that the joint is stronger than the bar.



Parallel metric threads are cut onto the enlarged ends. A nominal allowance of +50mm per threaded bar end should be made for cutting square and cold forging.

The threaded ends of the bars are protected by an external plastic sheath. Couplers, which are usually supplied attached to the bar, have their internal threads protected by an internal plastic end cap. For certain applications, especially where the BT Connection is

being used in deep pours, the coupler end caps may not prevent the ingress of concrete fines. For these applications, further protection may be required.

Couplers for bar diameters 32-40 contain a Guiding Chamfer on one end to assist in the installation of the heavier bars.

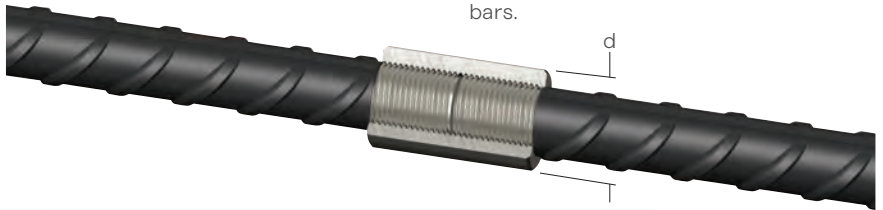

Dimensions

Bar Diameter (mm)		12	16	20	24	28	32	36	40
External Dia.	d	22	28	32	40	45	50	57	62
Coupler Length	l	28	40	48	60	66	78	92	98
Type A Thread Length	t	14	20	24	30	33	36	42	45
BT Round Locknut	In	12	12	12	15	15	15	20	20
Thread Size		M14	M20	M24	M30	M33	M36	M42	M45
Thread Pitch		2.0	2.5	3.0	3.5	3.5	4.0	4.5	4.5
Part No. BT coupler		BTC12	BTC16	BTC20	BTC24	BTC28	BTC32	BTC36	BTC40
Part No Type A thread		BTT12A	BTT16A	BTT20A	BTT24A	BTT28A	BTT32A	BTT36A	BTT40A
Part No Type B thread		BTT12B	BTT16B	BTT20B	BTT24B	BTT28B	BTT32B	BTT36B	BTT40B
Part No Type C1 thread		BTT12C1	BTT16C1	BTT20C1	BTT24C1	BTT28C1	BTT32C1	BTT36C1	BTT40C1
Part No Type C2 thread		BTT12C2	BTT16C2	BTT20C2	BTT24C2	BTT28C2	BTT32C2	BTT36C2	BTT40C2

Notes: All dimensions are approximate and subject to change without notice. Thread length of all couplers equal to 2t. BT coupler for size 50mm reinforcing bar is available on request. BT Hex Locknuts also available on request.

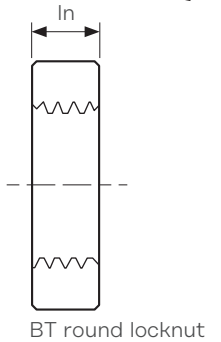

BT Type A

The BT Type A connection utilises internally threaded couplers with a single right hand thread and is suitable for applications where the continuation bar can be rotated. The ends of the bars are upset and threaded for half the length of the coupler (Type A thread).

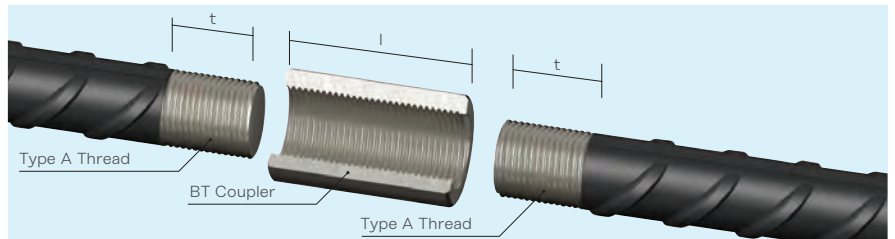

BT Type B

The BT Type B connection uses the same coupler as the Type A, but one bar is threaded for a full coupler length (Type B thread). It is used for applications where it is difficult but not impossible to rotate the continuation bar.

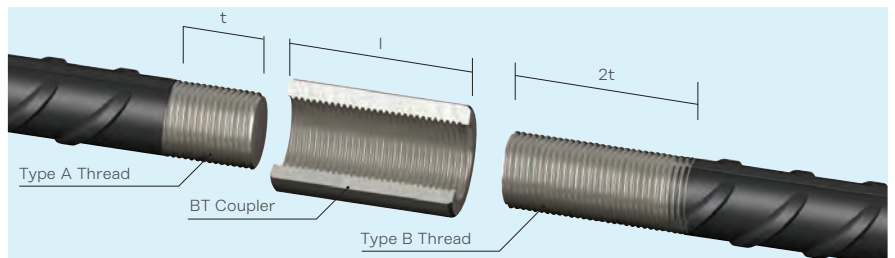

BT Type C

The BT Type C connection utilises the same coupler as for the Type A, together with locknuts and longer threads to the bar ends (Type C1 thread/Type C2 thread). Type C connections are used where the continuation bar cannot be rotated.

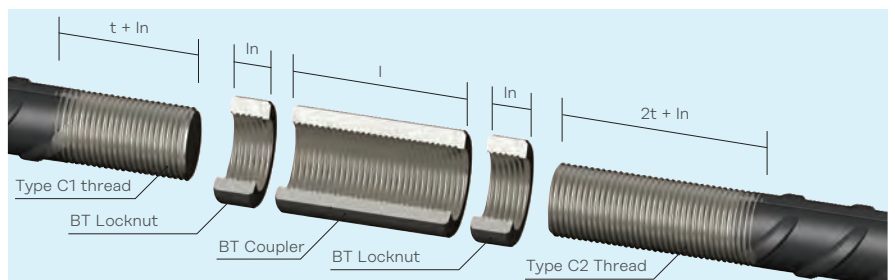

Important Notes: The additional thread lengths beyond the final coupler location on Type B and C connections are non-structural and are to be used for positioning purposes only. Couplers shown above do not include the Guiding Chamfer.

Two Stage Construction

In two stage construction utilising the Type C connection, it is essential to form a local breakout in the face of the first stage concrete. This will create the space for the Coupler and Locknut to run onto the thread of the fixed reinforcing bar. Refer to the installation guide available on the website for further details.

Bar End Preparation Facilities

BT threading equipment is located within our premises. We liaise with rebar suppliers to achieve scheduled, on-time deliveries. Couplers are usually supplied pre-fixed to the threaded bar ends.

Testing & Approvals

Ancon BT connections are manufactured to a strict quality regime of ISO 9001 and also complies in all respects to section 13.2.6 of AS 3600:2018 and AS 5100.5:2017 when used with reinforcing bar manufactured as per AS/NZS 4671:2019.

Full destructive tests have been performed to show compliance with various national and international requirements. The quality of the BT Connection is regularly monitored with internal tests.

For further information please contact us.



Reinforcing Bar Couplers

Installation

The BT Type A Connection

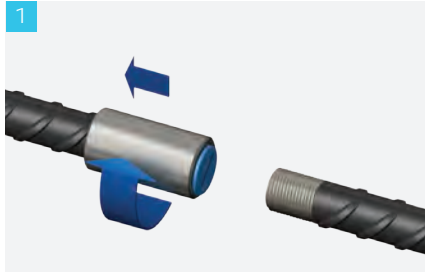

1 Screw the coupler to the rear of the thread on the fixed bar and lock tight. The bar end should be central within the coupler.

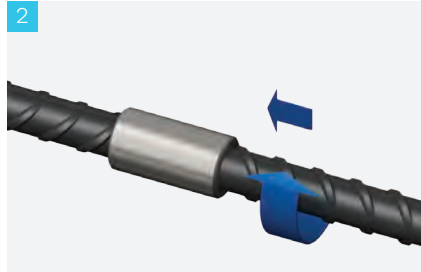

2 Remove the plastic cap from the coupler. Position and rotate the continuation bar in the coupler.

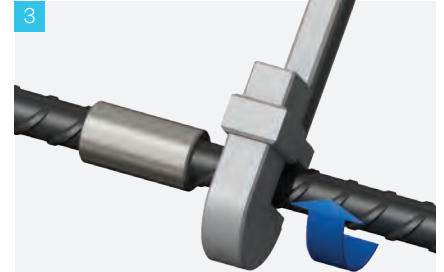

3 Tighten the joint using a wrench on the continuation bar. After tightening there should be no more than 2-4mm of thread exposed, depending on the diameter of the rebar.

The BT Type B Connection

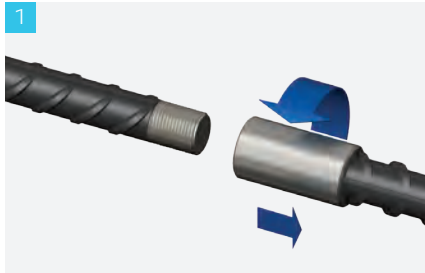

1 Screw the coupler to the rear of the thread on the continuation bar.



2 Position the continuation bar with the coupler against the end of the first bar.

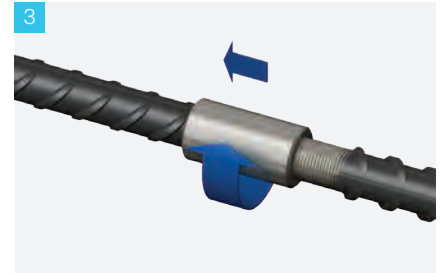

3 Rotate the coupler from the continuation bar to engage against the rear of the thread on the opposing bar and lock tight.

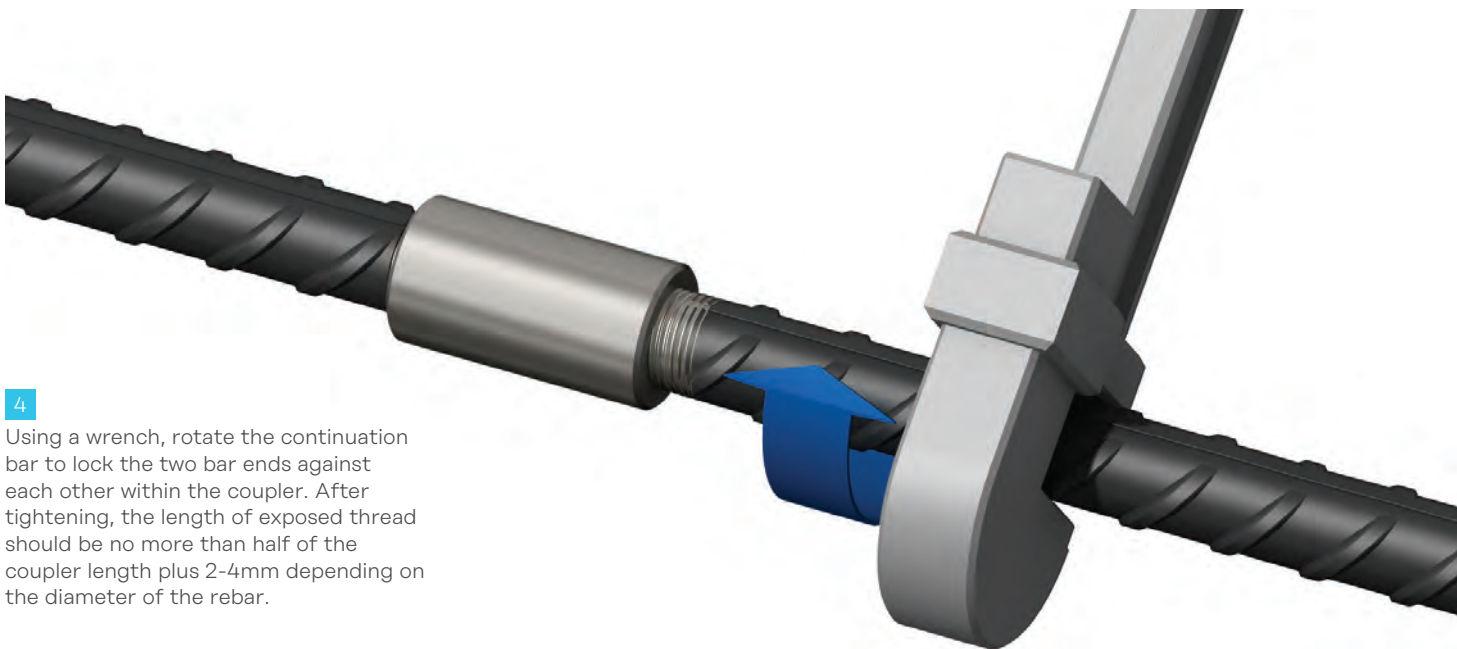

4 Using a wrench, rotate the continuation bar to lock the two bar ends against each other within the coupler. After tightening, the length of exposed thread should be no more than half of the coupler length plus 2-4mm depending on the diameter of the rebar.



To ensure structural integrity of the connection, any actions, such as on-site bending, which induce cold working of the bar in the threaded region are to be strictly avoided. Refer to the Ancon website for a more detailed installation guide.

Refer to the Leviat website for a more detailed installation guide.

Installation

BT Type C Connection

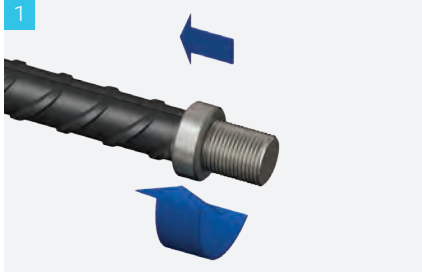

1 Screw the locknut onto the fixed bar with the Type C1 thread.



2 Screw the second locknut followed by the coupler to the end of the thread on the continuation bar with the C2 thread.

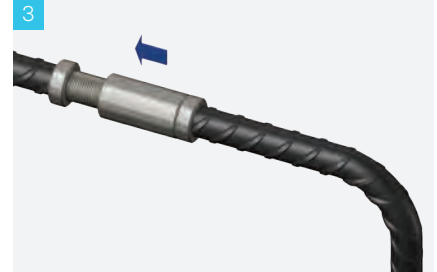

3 Position the continuation bar with the coupler against the end of the fixed bar.

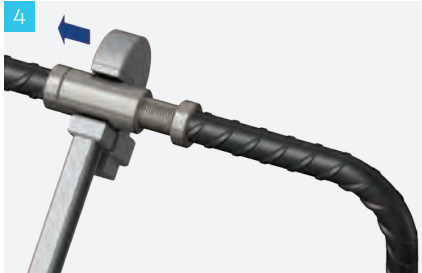

4 Screw the coupler from the continuation bar onto the fixed bar and lock tight with a wrench against the locknut.



5 Screw the locknut along the continuation bar to abut the coupler and lock tight with a wrench.



To ensure structural integrity of the connection, any actions, such as on-site bending, which induce cold working of the bar in the threaded region are to be strictly avoided. Refer to the Ancon website for a more detailed installation guide.

Refer to the Ancon website for a more detailed installation guide.



Reinforcing Bar Couplers

BT Transition Couplers*

BT Transition couplers are designed to connect reinforcing bars of different diameters whilst still maintaining the full tensile strength of both reinforcing bars, ensuring the failure mode is ductile failure of the smaller bar.

For Type A transition connections, both bars utilise standard Type A BT threads with a special coupler to connect the two bars.

Transition connections requiring types B or C systems use the standard BT thread for the smaller bar and a modified BT thread for the larger bar which uses a thread pitch matching the smaller thread to allow simultaneous rotation of the coupler on both bars.

Locknuts for Type C connections use the standard locknut for the smaller bar and a modified locknut with the modified thread pitch for the larger bar.

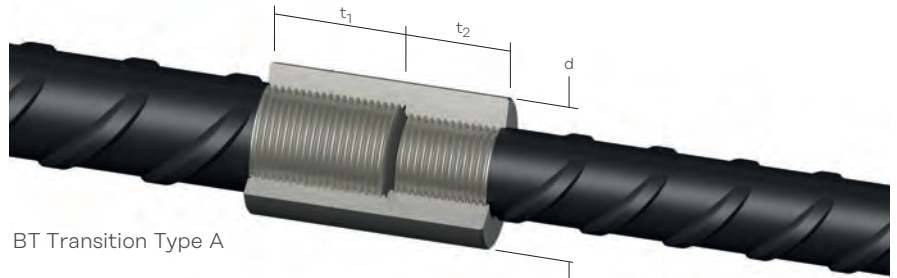

BT Transition Type A

BT Transition Couplers

Bar Diameter (mm)		12/16	16/20	20/24	24/28	28/32	32/36	36/40
External Diameter (mm)	d	28	32	40	45	50	57	62
Larger Type A Thread Length (mm)	t1	20	24	30	33	36	42	45
Smaller Type A Thread Length (mm)	t2	14	20	24	30	33	36	42
Coupler Length (mm)	t1 + t2	34	44	54	63	69	78	87
Thread Form		M14/M20	M20/M24	M24/M30	M30/M33	M33/M36	M36/M42	M42/M45
Type A Thread Pitch		2.0/2.5	2.5/3.0	3.0/3.5	3.5	3.5/4.0	4.0/4.5	4.5
Type B & C Thread Pitch		2	2.5	3	3.5	3.5	4	4.5

Other sizes are available on request. All transition couplers are made to order. Lead times and minimum order quantities may apply. Contact us for more details.

BT Transition Type A

The Type A transition connection utilises the same Type A BT threads as the standard system with a special internally threaded coupler to connect the two different sized cold-forged and threaded bar ends together. Type A connections are used where the continuation bar can be rotated.

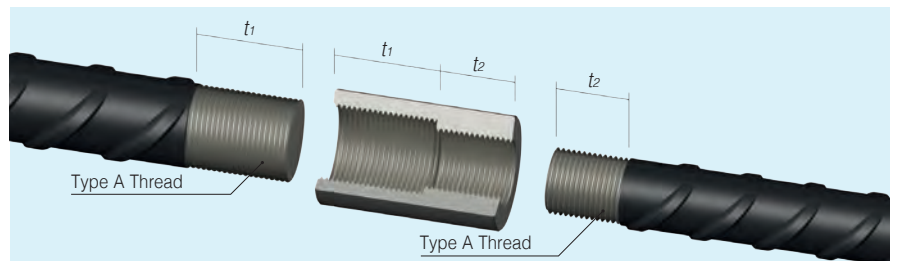

BT Transition Type B

The Type B connection utilises a longer thread on the smaller bar equal to the length of the coupler. The thread on the larger bar and the coupler is modified with a pitch matching the smaller thread. The coupler needs to be rotated from the smaller diameter rebar onto the larger. Type B connections are used where the continuation bar can be rotated for no more than one revolution.

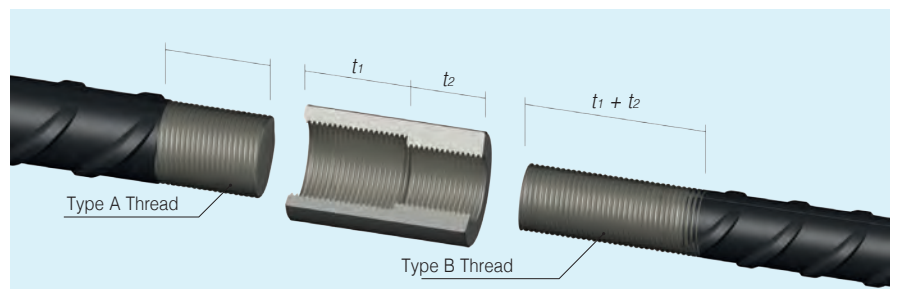

BT Transition Type C

The Type C connection utilises the same coupler and thread pitches as for the Type B, together with two locknuts and longer threads on the bar ends. The coupler needs to be rotated from the smaller diameter rebar onto the larger. Type C connections are used where the continuation bar cannot be rotated.

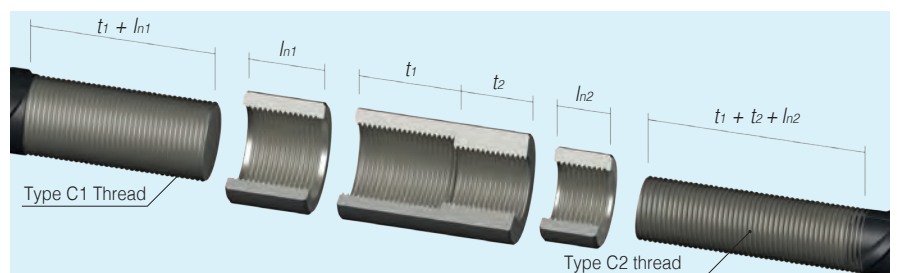

Important Note: The additional thread lengths beyond the final coupler location on Type B and C connections are non-structural and are to be used for positioning purposes only. *BT Transition Couplers are made to order to project specific requirements. Lead times and minimum order quantities may apply. Contact us for further information.

BT Stainless Steel Couplers*

The Ancon range of couplers is predominately designed for the joining of carbon steel bars, however stainless steel couplers are available for when stainless steel reinforcement is being used. These couplers are available in either grade 316 or Duplex stainless steel Grade 2205 to match the grades of rebar available in the market. Stainless steel couplers are suitable for projects of any size where the strength of the connection is required to match or exceed that of the parent bars, including large scale, high volume coupler applications.

The end of each bar to be joined is cut square and enlarged by cold forging. This increases the core diameter of the bar to ensure that the joint is stronger than the bar. Parallel metric threads are cut into the bar ends. A nominal allowance of +50mm per threaded bar end should be made for cutting square and cold forging.

Refer to Ancon Stainless Steel Reinforcement brochure for further information on stainless steel reinforcement.

The couplers are suitable for splicing BS 6744 Grade 500 stainless steel reinforcing bars and have been thoroughly tested to demonstrate compliance with static requirements from Eurocode 2 and BS8110.

There are currently no local standards covering stainless steel reinforcement. Stainless steel reinforcement is generally imported from mills in Europe. Available bar sizes are limited to European standards.

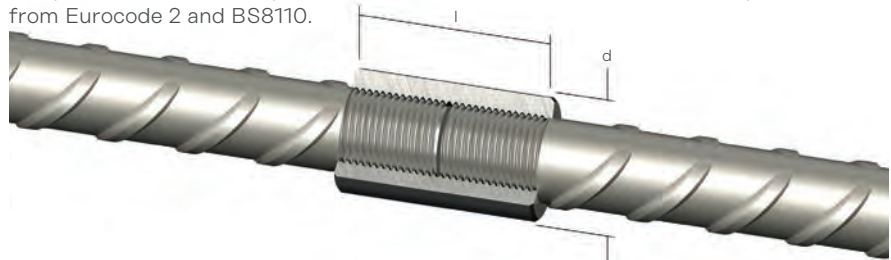

Dimensions

Bar Diameter	12	16	20	25	32	40
External Dia. d	22	30	35	42	55	35
Coupler Length l	28	40	48	60	78	98
Type A Thread Length t	14	20	24	30	36	45
Thread Size	M14	M20	M24	M30	M36	M45
Thread Pitch	2.0	2.5	3.0	3.5	4.0	4.5
Part No. BT SS coupler	BTC12S316/ BTC12S2205	BTC16S316/ BTC16S2205	BTC20S316/ BTC20S2205	BTC24S316/ BTC24S2205	BTC32S316/ BTC32S2205	BTC40S316/ BTC40S2205
Part No Type A thread	BTT12A	BTT16A	BTT20A	BTT24A	BTT32A	BTT40A
Part No Type B thread	BTT12B	BTT16B	BTT20B	BTT24B	BTT32B	BTT40B
Part No Type C1 thread	BTT12C1	BTT16C1	BTT20C1	BTT24C1	BTT32C1	BTT40C1
Part No Type C2 thread	BTT12C2	BTT16C2	BTT20C2	BTT24C2	BTT32C2	BTT40C2

Note: All dimensions are approximate and subject to change without notice. BT SS (Grade 316 or 2205) coupler for 50mm reinforcing bar is available on request.

BT Stainless Steel Type A

The Type A connection utilises an internally threaded coupler to join two cold-forged and threaded bar ends together. Each bar end is threaded to half the length of the coupler. Type A connections are used where the continuation bar can be rotated.

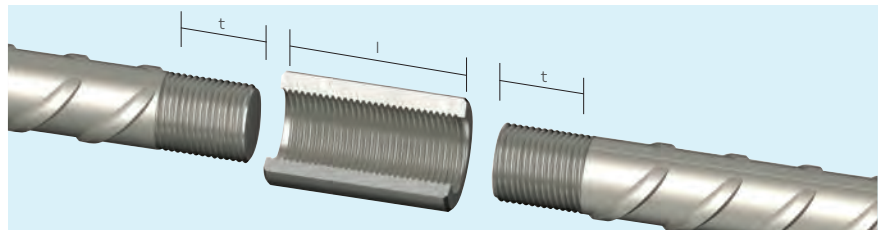

BT Stainless Steel Type B

The Type B connection utilises the same coupler as for the Type A, the difference being one bar end is threaded for the full coupler length. Type B connections are used where the continuation bar can be rotated for no more than one revolution.

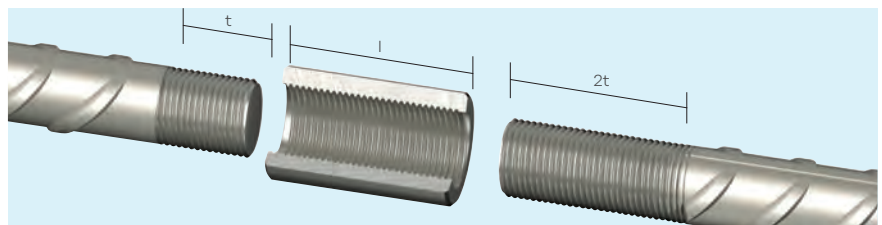

BT Stainless Steel Type C

The Type C connection utilises the same coupler as for the Type A, together with locknuts and longer threads to the bar ends. Type C connections are used where the continuation bar cannot be rotated.

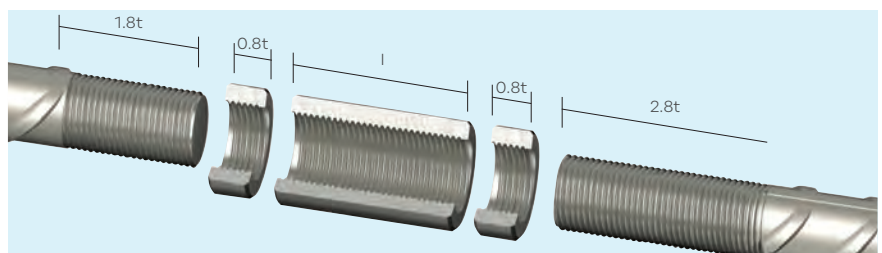

Important Note: The additional thread lengths beyond the final coupler location on Type B and C connections are non-structural and are to be used for positioning purposes only. *BT Stainless Steel Couplers are made to order to project specific requirements. Lead times and minimum order quantities may apply. Contact us for further information.

Reinforcing Bar Couplers

BT Weldable Couplers*

BT Weldable Couplers provide a convenient means of connecting reinforcing bars to structural steel plates or sections. One end has the BT thread form; the other end is prepared for welding to the steel.

BT Weldable Couplers are manufactured from either Steel Grade 1045 to ASTM A576 or Steel Grade C45R to EN10083. The load conditions at the connection must be determined by the designer responsible for this structural element, along with the type and size of weld required. Other important considerations are the type of electrode to be used, which must be matched to the properties of the plate and tube, and to the site conditions under which the welding will be undertaken. Welders should be qualified for the type of weld required.

Carbon Equivalent Value - The Carbon Equivalent value of these couplers may typically vary between 0.50 – 0.75, where the carbon equivalent value is given by $CEV = C + (Mn)/6 + (Ni+Cu)/15 + (Cr+Mo+V)/5$.

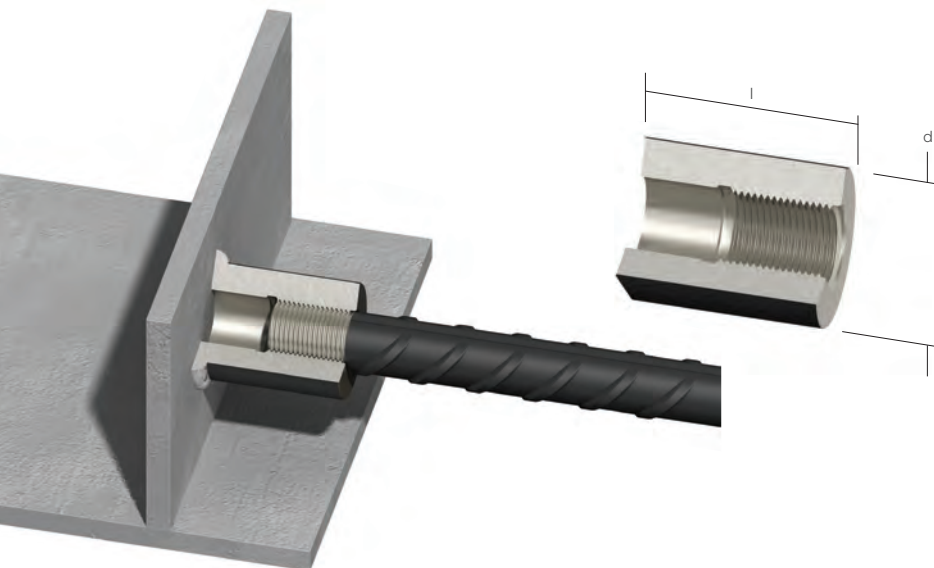

BT Weldable Couplers

Bar Diameter (mm)	12	16	20	24	28	32	36	40
Coupler Diameter (mm) d	28	33	38	48	52	57	65	72
Coupler Length (mm) l	30	40	48	60	65	72	75	90
Thread Form	M14x2.0	M20x2.5	M24x3.0	M30x3.5	M33x3.5	M36x4.0	M42x4.5	M45x4.5
Part No.	BTW12	BTW16	BTW20	BTW24	BTW28	BTW32	BTW36	BTW40

*BT Weldable Couplers are made to order to project specific requirements. Lead times and minimum order quantities may apply. Contact us for further information.

Installation

BT Weldable Couplers



The coupler must first be welded to the steelwork.

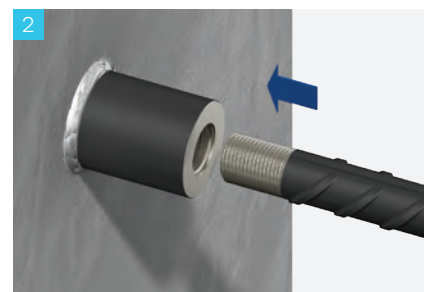

When ready to extend, remove the plastic end cap and position the continuation bar into the sleeve.

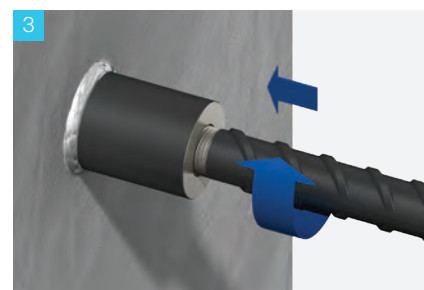

Rotate the bar into the coupler until tight.

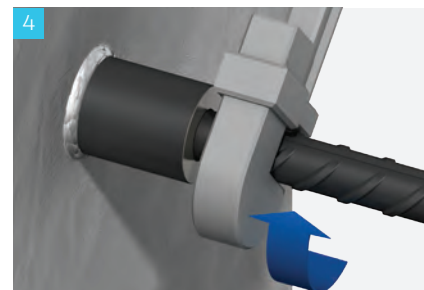

Tighten the continuation bar using a wrench.

BT Headed Anchors

BT Headed Anchors create an anchorage in the concrete, replacing the need for coggled or hooked bar ends. They can simplify scheduling and bar placement, and reduce congestion in the concrete.

Designed for use on 12mm to 50mm reinforcing bars, BT Headed Anchors are internally threaded with metric threads to suit the BT coupler system. They create a full strength joint, the mode of failure being bar break.

BT Headed Anchors can be used in accordance with clause 13.1.4 of AS 3600:2018 to reduce the development length of reinforcing bar. For typical applications, the development length is reduced to 10 times the diameter of the bar*. Refined calculations can be performed using the bearing area (A_{head}) values provided in the table below.

Note from AS 3600:2018 Clause 13.1.4

regarding the use of headed reinforcement:

Where the tensile force in a headed bar could give rise to bearing forces directed towards, or adjacent to, a free concrete surface, failure of the concrete cone between the head of the bar and the free concrete surface shall be investigated.

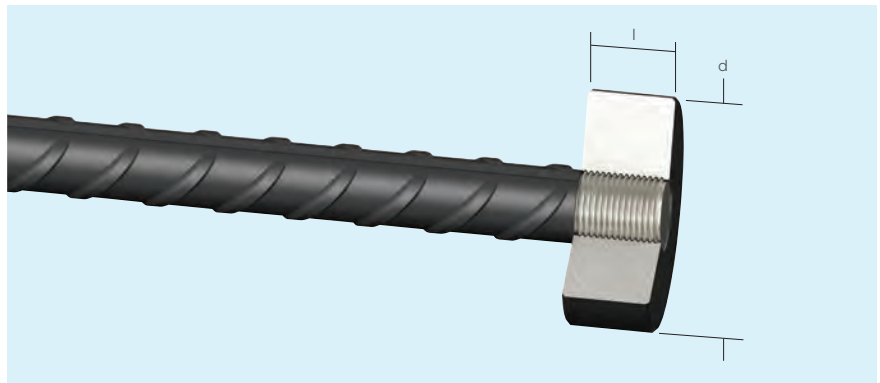

Bar Diameter (mm)		12	16	20	24	28	32	36	40
BT Headed Anchor Length (mm)	l	14	20	24	30	33	36	42	45
External Dia. (mm)	d	38	50	65	75	90	105	120	130
Net Bearing Area (mm ²)	A_{head}	1021	1762	3004	3965	5746	7855	10292	12017
Thread Size		M14 x 2.0	M20 x 2.5	M24 x 3.0	M30 x 3.5	M33 x 3.5	M36 x 4.0	M42 x 4.5	M45 x 4.5
Part No.		AA12	AA16	AA20	AA24	AA28	AA32	AA36	AA40

Note: AA50 BT Headed Anchors can be manufactured, for details contact us.

*Reduction in development length based on 32MPa concrete and where $K1 = K3 = 1$.

Reinforcing Bar Couplers

MBT Mechanically Bolted Couplers

The MBT range of couplers provides a cost-effective method of joining reinforcing bars, particularly when the fixed bar is already in place.

They are easy to install and achieve failure loads higher than 110% of the characteristic yield strength of grade 500 reinforcing bar. Neither bar end preparation to form threads, nor bar rotation are required. MBT couplers can also be used to join imperial, plain round or deformed reinforcing bars.

The bar ends are supported within the coupler by two serrated saddles, and as the lockshear bolts are tightened, the conical ends embed themselves into the bar. As this happens the serrated saddles bite into both the bar and the shell of the coupler. The lockshear bolts of couplers up to and including the MBT20C coupler can be tightened using a ratchet wrench. For larger couplers a nut runner is recommended.

In all cases heavy duty sockets should be used. When the pre-determined tightening torque for the bolts is reached, the heads shear off leaving the top of the installed bolt slightly proud of the coupler. This provides an instant visual check of correct installation.

Note: Impact tools must not be used to tighten lockshear bolts.

MBT Coupler Connection

The MBT Coupler Connection is used to connect reinforcing bars of the same size.

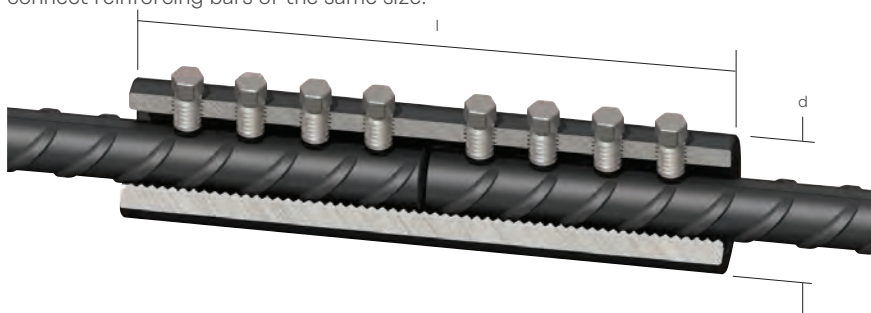

Testing & Approvals

MBT couplers are manufactured to a strict quality regime accredited to ISO 9001 and have been extensively tested in Australia using grade 500N reinforcement bar manufactured as per AS/NZS 4671:2019. The connections using MBT couplers, in common 12-20 mm sizes, exceed the tensile strength of the reinforcement bar and comply with requirements of section 13.2.6 of AS 3600:2018 and AS 5100.5:2017.

Connections with sizes 24-40 mm MBT couplers achieve failure loads higher than 110% of the characteristic yield strength of grade 500N reinforcement bar.

For further technical information, please contact us at technical.au@leviat.com

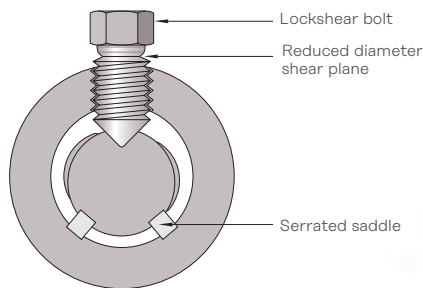

Section showing the embedment of the lockshear bolts and saddles into the bar and the shell of the coupler.



MBT Couplers Dimensions

Bar Diameter (mm)		12	16	20	24	28	32	36	40
External Diameter	d	33.4	42.2	48.3	54.0	66.7	71.0	75.0	81.0
Total Length	l	140	160	204	258	312	312	420	484
Socket Size A/F (ins)		1/2	1/2	1/2	5/8	5/8	5/8	3/4	3/4
No. of Bolts		6	6	8	8	10	10	12	14
Part No		MBT12C	MBT16C	MBT20C	MBT24C	MBT28C	MBT32C	MBT36C	MBT40C

Note: MBT50C couplers can be manufactured. For details contact us.

Installation

MBT Coupler Connection

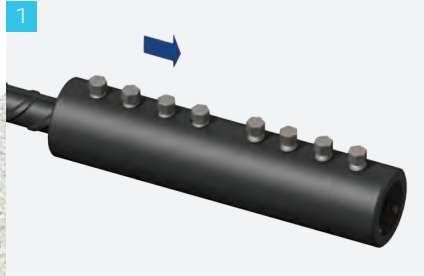

1 Place the coupler over the end of the bar to half the coupler length +/- 6mm and finger tighten the lockshear bolts onto the bar. Check the alignment and make any necessary adjustments.

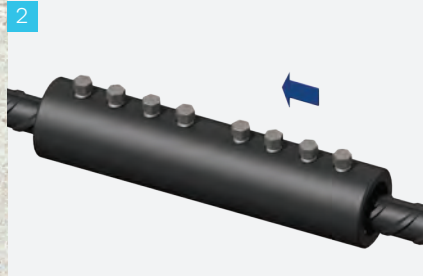

2 Place the other bar end into the coupler until it pushes up against the first bar and finger tighten the remaining lockshear bolts. Check alignment and make any adjustments.

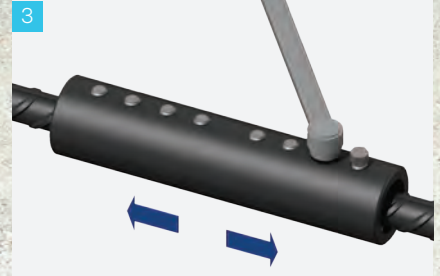

3 On one half of the coupler, starting from the centre and working outwards, partly tighten the lockshear bolts using either a ratchet wrench or a nut-runner as appropriate. Do not use impact tools. Repeat again, this time fully tightening the lockshear bolts until the bolt heads shear off.

Repeat the above for the other half of the coupler.

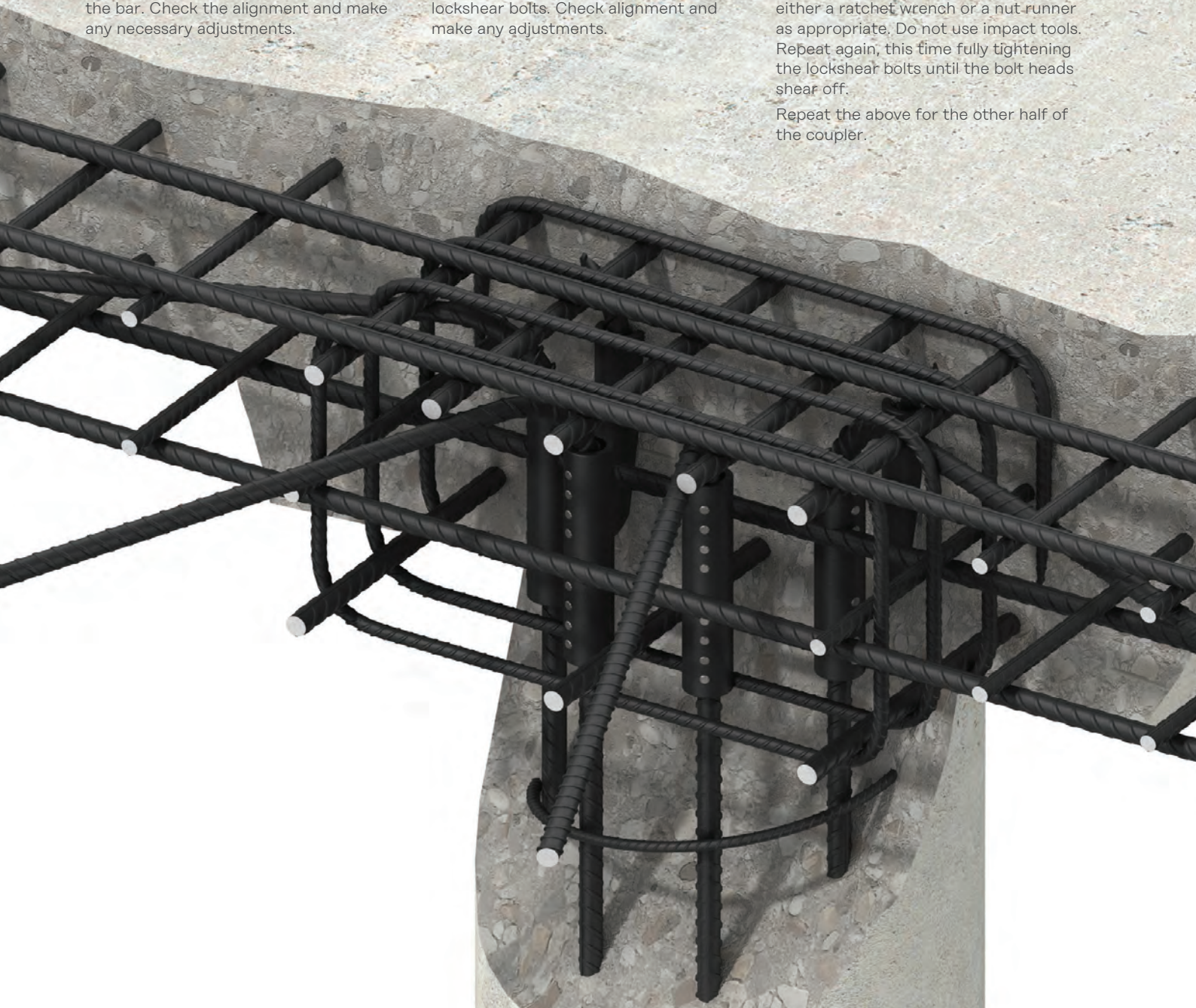

Reinforcing Bar Couplers



Repair and Remedial Work

For applications involving replacement of corroded or damaged bars, the replacement bar is cut approximately 5mm shorter to allow clearance for insertion between the sound ends of the original bars. MBT couplers are pushed fully over both ends of the replacement bar and temporarily held in position.

The replacement bar is then correctly positioned and the couplers moved to a previously marked position on the existing bars indicating half the length of the coupler. The lockshear bolts are tightened to complete the installation.

MBT Transition Series*

The MBT Transition series of couplers provides an effective solution for connecting bars of different diameters.

Transition couplers have all the benefits of the MBT Coupler Connection and are designed to achieve failure loads higher than 110% of the characteristic yield strength of grade 500 reinforcing bar.

They can be installed without any preparation to the bar ends and without any need to rotate bars. The coupler can be rotated to allow access to the bolts for tightening with either a ratchet wrench or a nut runner. In all cases heavy duty sockets should be used. Transition couplers are non-standard and are made to order.

Note: Impact tools should not be used to tighten lockshear bolts.

*MBT Transition Couplers are made to order to project specific requirements. Lead times and minimum order quantities may apply. Contact us for further information.

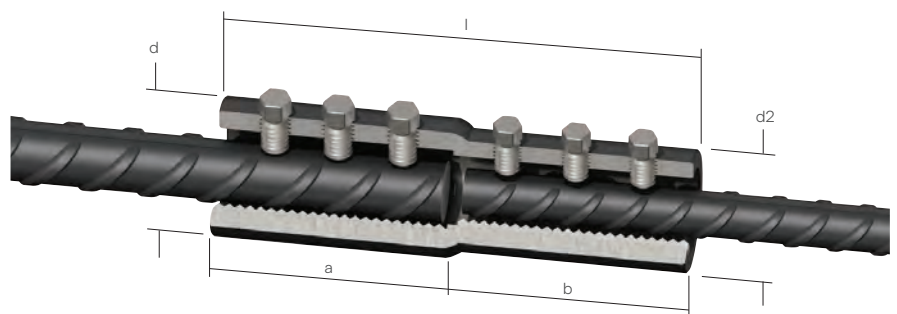

MBT Transition Series Dimensions

Bar Diameter		20/12	20/16	24/16	24/20	32/20	32/24	40/32
External Diameter	d	48.3	48.3	54	54	71	71	81
External Diameter	d2	33.4	48.3	42.2	54	48.3	54	71
Total Length	l	150	160	155	180	177	231	335
Individual Lengths	a:b	80:70	80:80	75:80	90:90	75:102	102:129	178:157
Socket Size A/F (ins)	a:b	1/2:1/2	1/2:1/2	5/8:1/2	5/8:1/2	5/8:1/2	5/8:5/8	3/4:5/8
No. of Bolts	a:b	3:3	3:3	2:3	3:3	2:4	3:4	5:5
Part No		MBT20/12C	MBT20/16C	MBT24/16C	MBT24/20C	MBT32/20C	MBT32/24C	MBT40/32C

Note: Other sizes available upon request. Contact us for further information.



Installation

MBT Transition Couplers

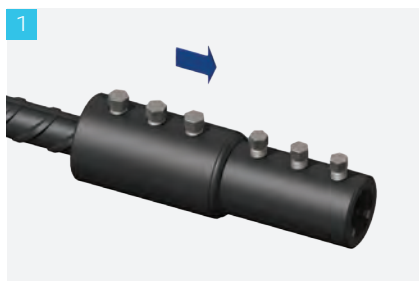

1 Place the coupler over the end of the bar to the appropriate depth +/- 6mm and finger tighten the lockshear bolts onto the bar. Check the alignment and make any necessary adjustments.

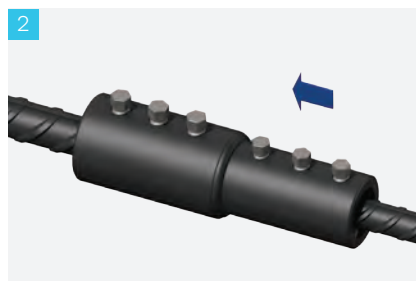

2 Place the other bar end into the coupler until it pushes up against the first bar and finger tighten the remaining lockshear bolts. Check alignment and make any adjustments.

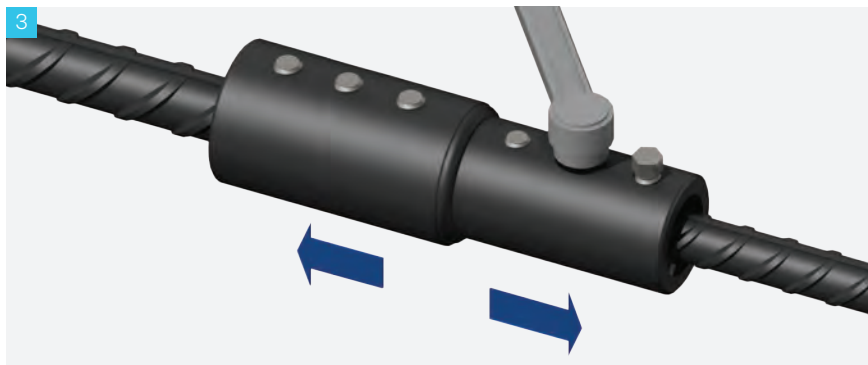

3 On one half of the coupler, starting from the centre and working outwards, partly tighten the lockshear bolts using either a ratchet wrench or a nut runner as appropriate. Do not use impact tools. Repeat again, this time fully tightening the lockshear bolts until the bolt heads shear off.

Repeat the above for the other half of the coupler

Reinforcing Bar Couplers

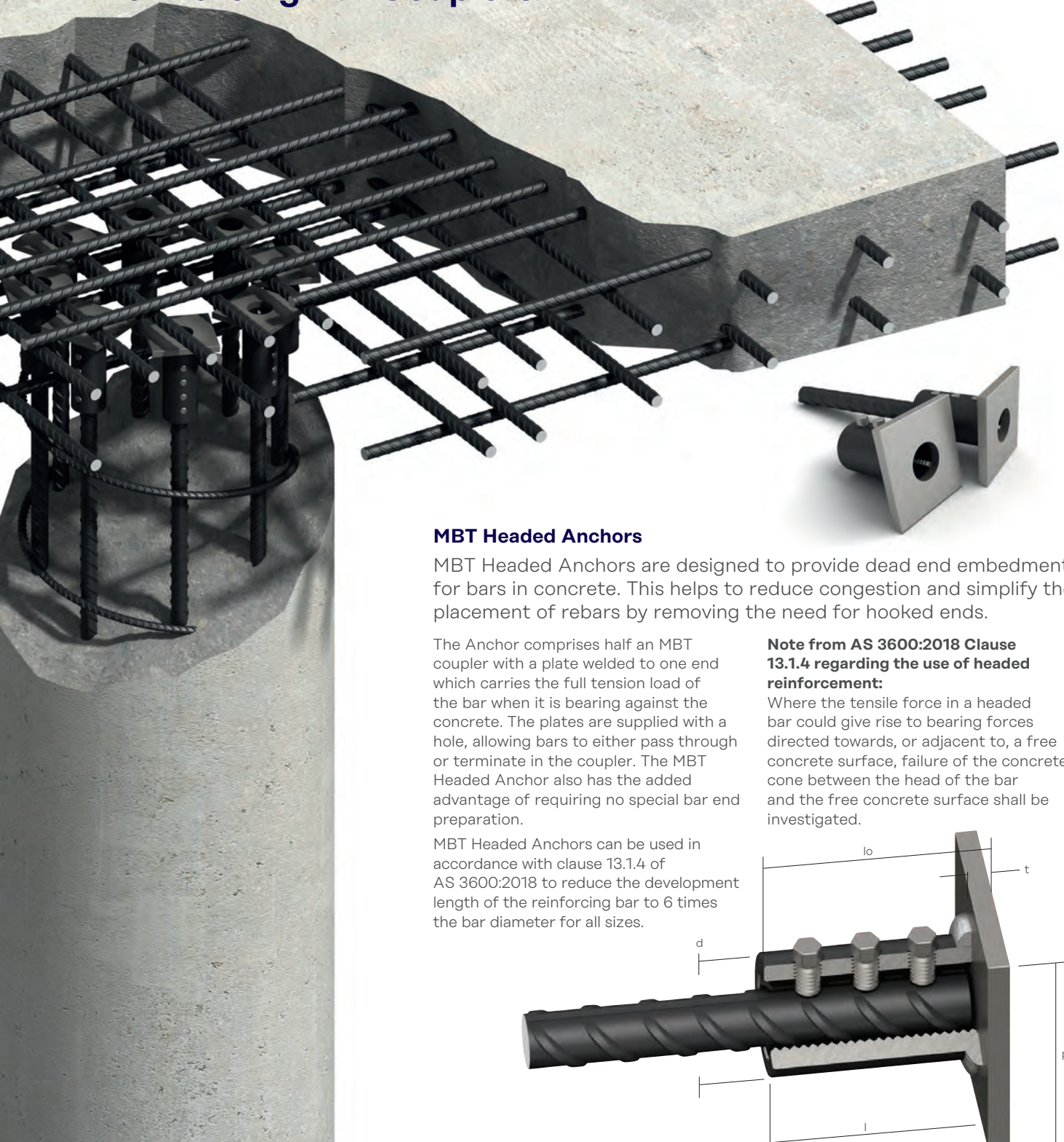

MBT Headed Anchors

MBT Headed Anchors are designed to provide dead end embedment for bars in concrete. This helps to reduce congestion and simplify the placement of rebars by removing the need for hooked ends.

The Anchor comprises half an MBT coupler with a plate welded to one end which carries the full tension load of the bar when it is bearing against the concrete. The plates are supplied with a hole, allowing bars to either pass through or terminate in the coupler. The MBT Headed Anchor also has the added advantage of requiring no special bar end preparation.

MBT Headed Anchors can be used in accordance with clause 13.1.4 of AS 3600:2018 to reduce the development length of the reinforcing bar to 6 times the bar diameter for all sizes.

Note from AS 3600:2018 Clause 13.1.4 regarding the use of headed reinforcement:

Where the tensile force in a headed bar could give rise to bearing forces directed towards, or adjacent to, a free concrete surface, failure of the concrete cone between the head of the bar and the free concrete surface shall be investigated.

Bar Diameter (mm)		10	12	16	20	24	28	32	36	40
External Diameter	d	33.4	33.4	42.2	48.3	54.0	66.7	71.0	75.0	81.0
Coupler Length	l	55	75	82	104	129	156	156	215	247
Total Length	lo	65	85	92	114	139	168	171	230	262
Plate Thickness	t	10	10	10	10	10	12	15	15	15
Plate w x h	p	70	70	80	90	100	110	130	150	150
Socket Size A/F (ins)		1/2	1/2	1/2	1/2	5/8	5/8	5/8	3/4	3/4
No of Bolts		2	3	3	4	4	5	5	6	7
Approx Weight (kg)		0.64	0.74	1.07	1.58	2.29	4.14	4.72	5.83	8.30

Part No. MBTHA10H MBTHA12H MBTHA16H MBTHA20H MBTHA24H MBTHA28H MBTHA32H MBTHA36H MBTHA40H

Note: Minimum compressive strength of concrete 25MPa.



Other Ancon Products

Reinforcement Continuity Systems

Reinforcement Continuity Systems are an increasingly popular means of maintaining continuity of reinforcement at construction joints in concrete. The Ancon Keybox system eliminates the need to drill shuttering and can simplify formwork design, thereby accelerating the construction process. It is available in both standard units and special configurations. Ancon KSN threaded anchors eliminate the need for on-site bar straightening and are available for use with 12mm, 16mm and 20mm diameter reinforcement. The system is also available with a re-useable rebate former.

Shear Load Connectors

Ancon DSD and ESD Shear Load Connectors are used to transfer shear across expansion and contraction joints in concrete. They are more effective at transferring load and allowing movement to take place than standard dowels, and can be used to eliminate double columns at structural movement joints in buildings. A 'Lockable' dowel is also available for temporary movement joints in post-tensioned concrete frames.

Punching Shear Reinforcement

Ancon Shearfix is used within a slab to provide additional reinforcement from punching shear around columns. The system consists of double-headed steel studs welded to flat rails and is designed to suit the load conditions and slab depth at each column using our free calculation software.

Masonry Support Systems

Masonry cladding on concrete or steel frames is normally supported from stainless steel support systems. Ancon MDC Systems create a continuous angle to support the outer leaf of masonry. Ancon Individual Brackets support masonry features such as curves and arches.

Channel and Bolt Fixings

Leviat offers a wide range of channels and bolts in order to fix stainless steel masonry support, restraints and windposts to structural frames. Cast-in channels and expansion bolts are used for fixing to the edges of concrete floors and beams. A range of stainless steel set screws and self-drill self-tap screws are designed to fix to steel frames.

Special Fabrications

Leviat is an ASSDA accredited specialist fabricator and has a wealth of experience in working with a variety of material grades. High integrity steel components are supplied to a wide range of industries including Civil Engineering, Building, Infrastructure, Water Treatment, Nuclear and Mining.



Design Program Available



Design Program Available

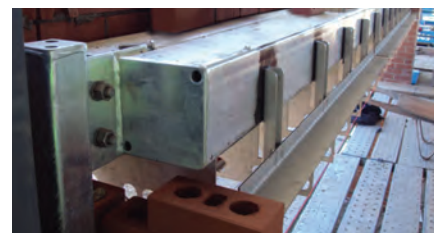

© Thiess Energy Australia



MBT Electric Wrench

To facilitate the installation of MBT couplers Ancon Electric Wrenches are available for purchase or hire. The smooth continuous action of the wrench prevents the early shearing of the lockshear bolts and damage to threads. The wrench is supplied with specially hardened heavy duty sockets. Please contact us for details.



Note: Impact tools should not be used to tighten lockshear bolts. In all cases heavy duty sockets should be used.

Contact Leviat locally

For more information on the products featured here, please contact Leviat:

General Enquiries

T: 1300 304 320

Leviat.com

Sales Offices and Production

New South Wales, Sydney

98 Kurrajong Avenue
Mont Druitt | Sydney
NSW 2770

Queensland

4/15 Terrace Place
Murarrie | Brisbane
QLD 4172

New South Wales, Casino

10 Irving Drive
Casino
NSW 2470

Western Australia

18 Tennant Street
Welshpool | Perth
WA 6106

Victoria

9/63-69 Pipe Road
Laverton North | Melbourne
VIC 3026

Contact Leviat worldwide

Australia

98 Kurrajong Avenue,
Mount Druitt, Sydney, NSW 2770
Tel: +61 - 2 8808 3100
Email: info.au@leviat.com

Austria

Leonard-Bernstein-Str. 10
Saturn Tower, 1220 Wien
Tel: +43 - 1 - 259 6770
Email: info.at@leviat.com

Belgium

Industrielaan 2
1740 Ternat
Tel: +32 - 2 - 582 29 45
Email: info.be@leviat.com

China

Room 601 Tower D,
Vantone Centre
No. A6 Chao Yang Men Wai Street
Chaoyang District
Beijing P.R. China 100020
Tel: +86 - 10 5907 3200
Email: info.cn@leviat.com

Czech Republic

Business Center Šafránková
Šafránková 1238/1
155 00 Praha 5
Tel: +420 - 311 - 690 060
Email: info.cz@leviat.com

Finland

Vädursgatan 5
412 50 Göteborg / Sweden
Tel: +358 (0)10 6338781
Email: info.fi@leviat.com

France

6, Rue de Cabanis
FR 31240 L'Union
Toulouse
Tel: +33 - 5 - 34 25 54 82
Email: info.fr@leviat.com

Germany

Liebigstrasse 14
40764 Langenfeld
Tel: +49 - 2173 - 970 - 0
Email: info.de@leviat.com

India

309, 3rd Floor
Orion Business Park
Ghodbunder Road
Kapurbawdi, Thane West,
Thane, Maharashtra 400607
Tel: +91 - 22 2589 2032
Email: info.in@leviat.com

Italy

Via F.lli Bronzetti 28
24124 Bergamo
Tel: +39 - 035 - 0760711
Email: info.it@leviat.com

Malaysia

28 Jalan Anggerik Mokara 31/59
Kota Kemuning,
40460 Shah Alam Selangor
Tel: +603 - 5122 4182
Email: info.my@leviat.com

Netherlands

Oostermaat 3
7623 CS Borne
Tel: +31 - 74 - 267 14 49
Email: info.nl@leviat.com

New Zealand

2/19 Nuttall Drive, Hillsborough,
Christchurch 8022
Tel: +64 - 3 376 5205
Email: info.nz@leviat.com

Norway

Vestre Svanholmen 5
4313 Sandnes
Tel: +47 - 51 82 34 00
Email: info.no@leviat.com

Philippines

2933 Regus, Joy Nostalg,
ADB Avenue, Ortigas Center
Pasig City
Tel: +63 - 2 7957 6381
Email: info.ph@leviat.com

Poland

Ul. Obornicka 287
60-691 Poznań
Tel: +48 - 61 - 622 14 14
Email: info.pl@leviat.com

Singapore

14 Benoi Crescent
Singapore 629977
Tel: +65 - 6266 6802
Email: info.sg@leviat.com

Spain

Polígono Industrial Santa Ana
c/ Ignacio Zuloaga, 20
28522 Rivas-Vaciamadrid
Tel: +34 - 91 632 18 40
Email: info.es@leviat.com

Sweden

Vädursgatan 5
412 50 Göteborg
Tel: +46 - 31 - 98 58 00
Email: info.se@leviat.com

Switzerland

Grenzstrasse 24
3250 Lyss
Tel: +41 (0)800 22 66 00
Email: info.ch@leviat.com

United Arab Emirates

RA08 TB02, PO Box 17225
JAFZA, Jebel Ali, Dubai
Tel: +971 (0)4 883 4346
Email: info.ae@leviat.com

United Kingdom

President Way,
President Park,
Sheffield S4 7UR
Tel: +44 - 114 275 5224
Email: info.uk@leviat.com

USA / Canada

6467 S Falkenburg Road
Riverview, FL 33578
Tel: (800) 423-9140
Email: info.us@leviat.us

For countries not listed
Email: info@leviat.com

Notes regarding this document

© Protected by copyright. The information in this publication is based on state-of-the-art technology at the time of publication. In every case, project working details should be entrusted to appropriately qualified and experienced persons. Leviat shall not accept liability for the accuracy of the information in this document or for any printing errors. We reserve the right to make technical and design changes at any time. With a policy of continuous product development, Leviat reserves the right to modify product design and specification at any time.

Leviat®