

Leviat[®]
A CRH COMPANY

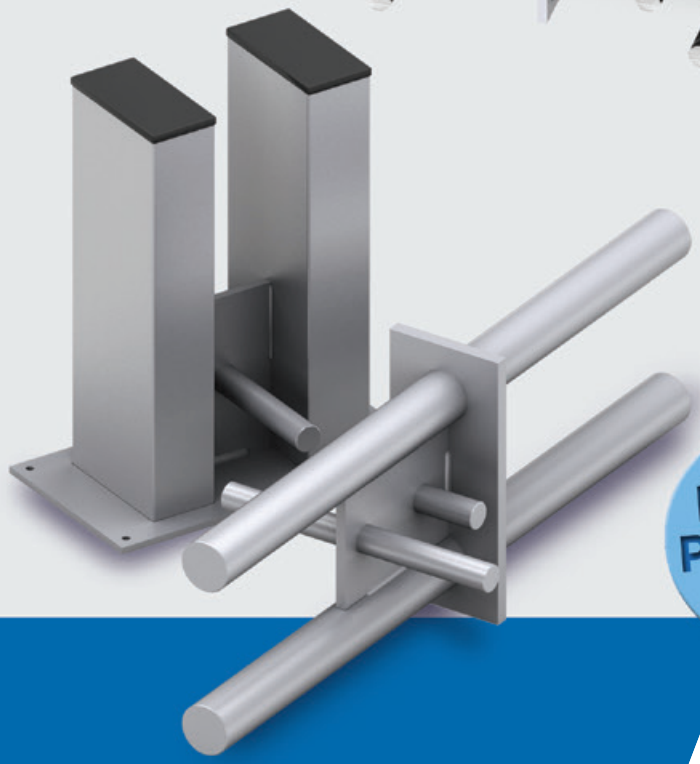
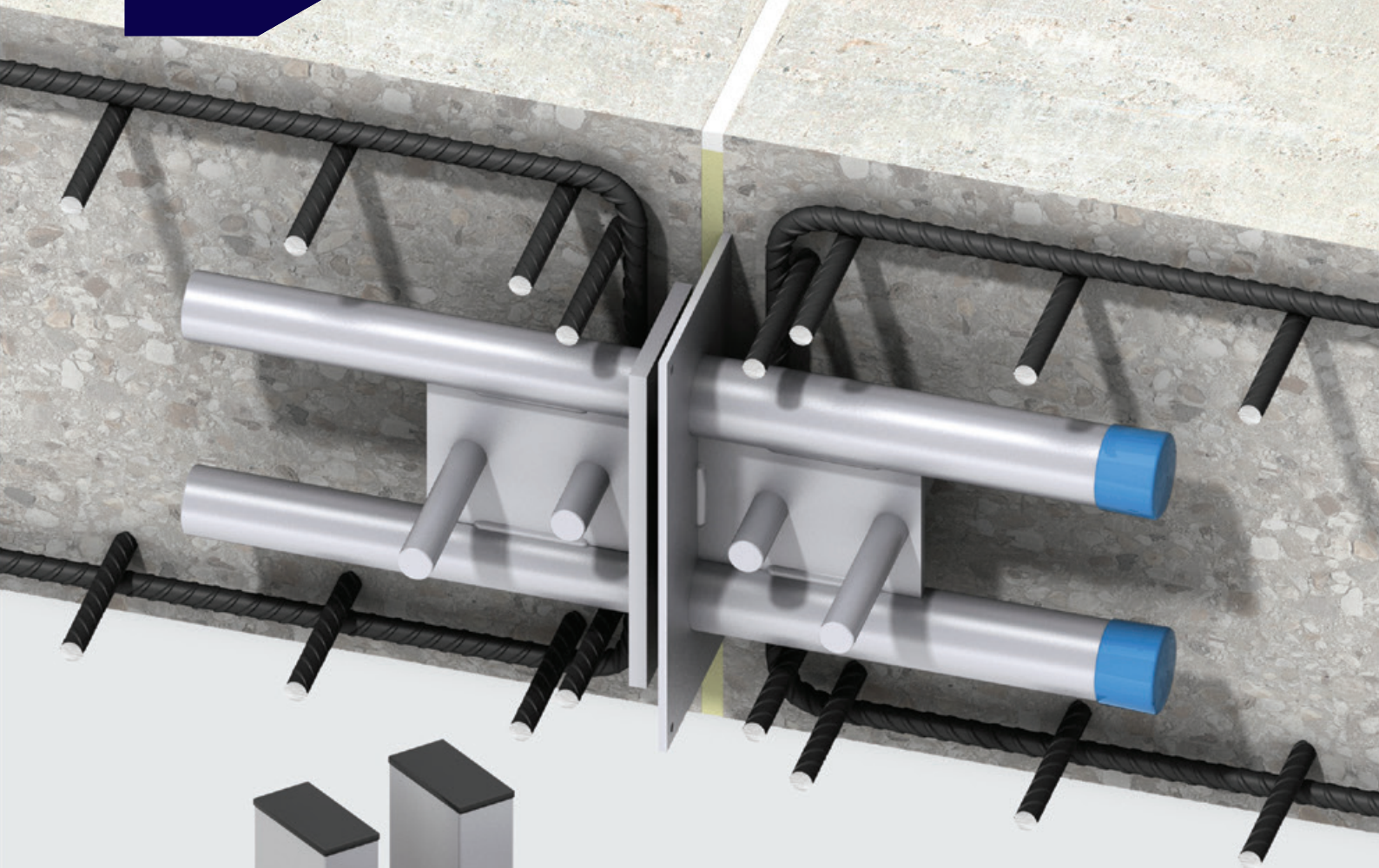

DSD/Q
**Design
Program
Available**

Ancon[®]

Shear Load Connectors

for the Construction Industry

July 2023



We are one team. **We are Leviat.**

Leviat is the new name of CRH's construction accessories companies worldwide.

Under the Leviat brand, we have united the expertise, skills and resources of Ancon and its sister companies to create a world leader in fixing, connecting and anchoring technology.

The products you know and trust will remain an integral part of Leviat's comprehensive brand and product portfolio. As Leviat, we can offer you an extended range of specialist products and services, greater technical expertise, a larger and more agile supply chain and better, faster innovation.

By bringing together CRH's construction accessories family as one global organisation, we are better equipped to meet the needs of our customers, and the demands of construction projects, of any scale, anywhere in the world.

This is an exciting change. Join us on our journey.

Read more about Leviat at [Leviat.com](https://www.leviat.com)



Our product brands include:

Ancon[®]

Connolly

HALFEN

HELIFIX

ISEDIO

PLAKA



60

locations

sales in
30+
countries

3000

people worldwide

Imagine. Model. Make.

Leviat.com

Shear Load Connectors

Efficiently transfer shear load across movement joints in concrete

Reinforced concrete is an important construction material. It offers strength, durability and can be formed into a variety of shapes. Concrete structures are designed with expansion and contraction joints at appropriate places to allow movement to take place. The design of the joint is important for the overall design to function correctly.

Ancon shear load connectors offer significant advantages over plain dowels. These connectors are more effective at transferring load and allowing movement to take place, easier to fix on site and can prove a more cost-effective solution.

Each connector is a two-part assembly comprising a sleeve and a dowel component. Installation is a fast and accurate process, drilling of either formwork or concrete

is not required. The sleeve is simply nailed to the formwork ensuring subsequent alignment of the dowel, essential for unhindered movement.

They are manufactured from stainless steel to ensure a high degree of corrosion resistance with no requirement for additional protection.

In most cases, dowelled or keyed joints can be replaced by joints incorporating Ancon shear load connectors. They can be used for movement joints in floor slabs, suspended slabs, and for replacing double columns and beams at structural movement joints.

Applications in civil engineering include joints in bridge parapets, bridge abutments and diaphragm wall construction.

Building Information Modelling

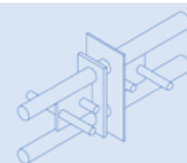

BIM objects of Ancon products are now available to download from www.ancon.com.au

Contents

Dowelled and Keyed Joints	6	DSD and DSDQ Connectors	14-18
Ancon Solutions to Joints	7	ESD, ESDQ, ED and Acoustic Connectors	19-22
Building Applications	8	Fire Protection	23
Civil Engineering Applications	9	Lockable Dowels	24
Ancon Shear Connector Range	10-11	Projects	25
Installation Procedure	12	Other Ancon Products	25
Design Resistances	13		



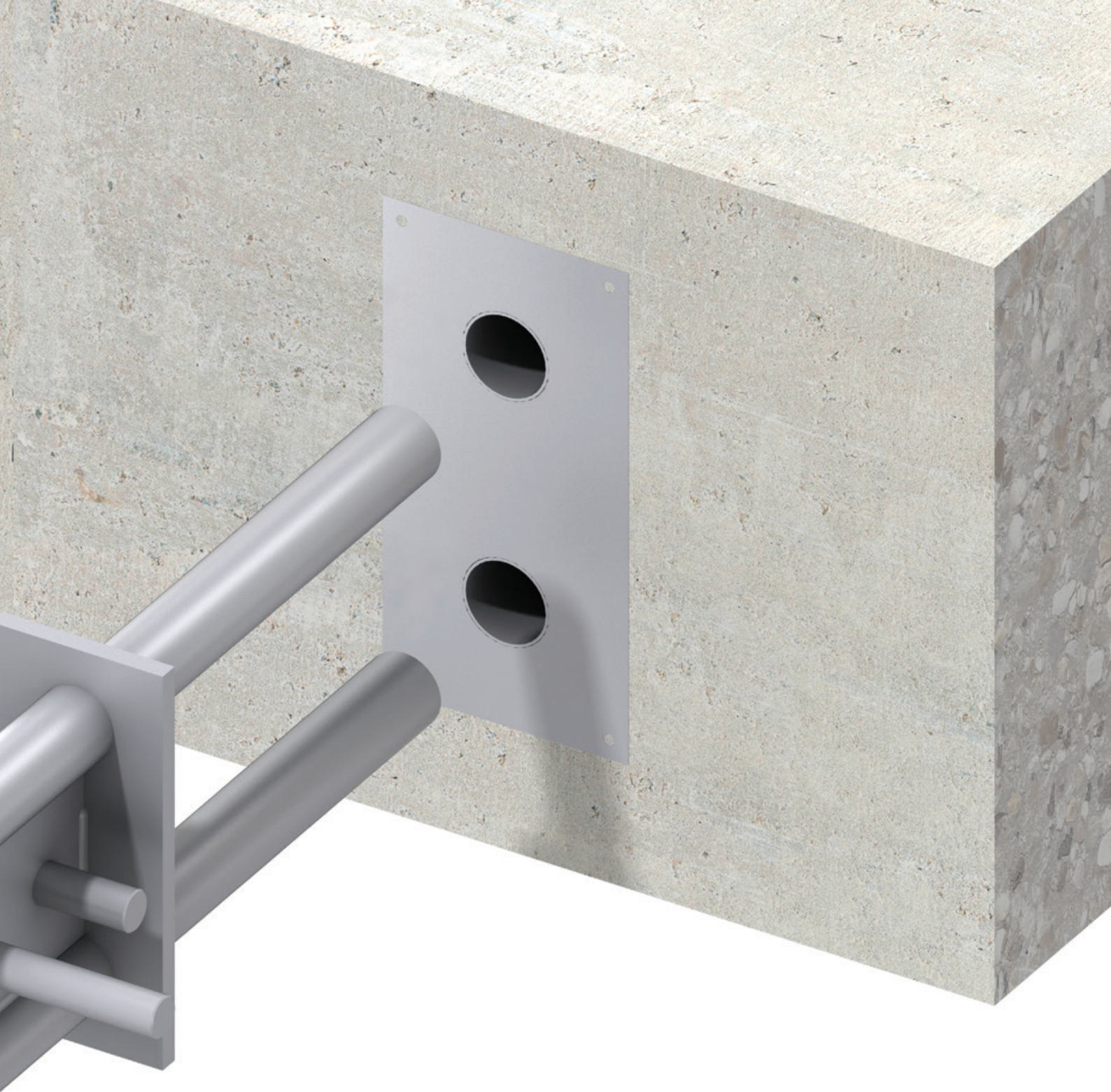

High Load Transfer



Sleeve Component Accommodates Movement



'Q' Range Allows Lateral Movement



Two Step Installation Guarantees Alignment



Corrosion Resistant Stainless Steel



Acoustic Resilient Dowel Available



Design Program Available



BIM Objects Available



Shear Load Connectors

Dowelled Joints

Dowels are used to transfer shear across construction and movement joints in concrete. They are often either cast or drilled into the concrete. A single row of short thick dowels provides reasonable shear transfer but will experience massive deformation. This can lead to stress concentrations, resulting in subsequent spalling of the concrete.

Where dowels are used across expansion and contraction joints, half the length of the bar is debonded to allow movement to take place.

Dowelled joints either require formwork to be drilled for the dowels to pass through, or concrete to be drilled for dowels to be resin fixed in one side.

At movement joints, dowels will need to be accurately aligned in both directions to ensure movement can actually take place, otherwise cracking is likely to occur.

Plain dowels are not very effective when used across joints wider than 10mm.

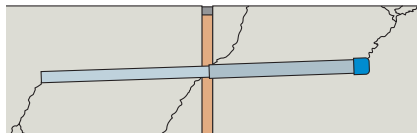

Keyed Joints

Keyed joints require complicated formwork to create the tongue and groove. If the joint is not formed correctly, differential movement can take place. Load is transferred through the locally reduced section of the joint which can at times result in cracking.

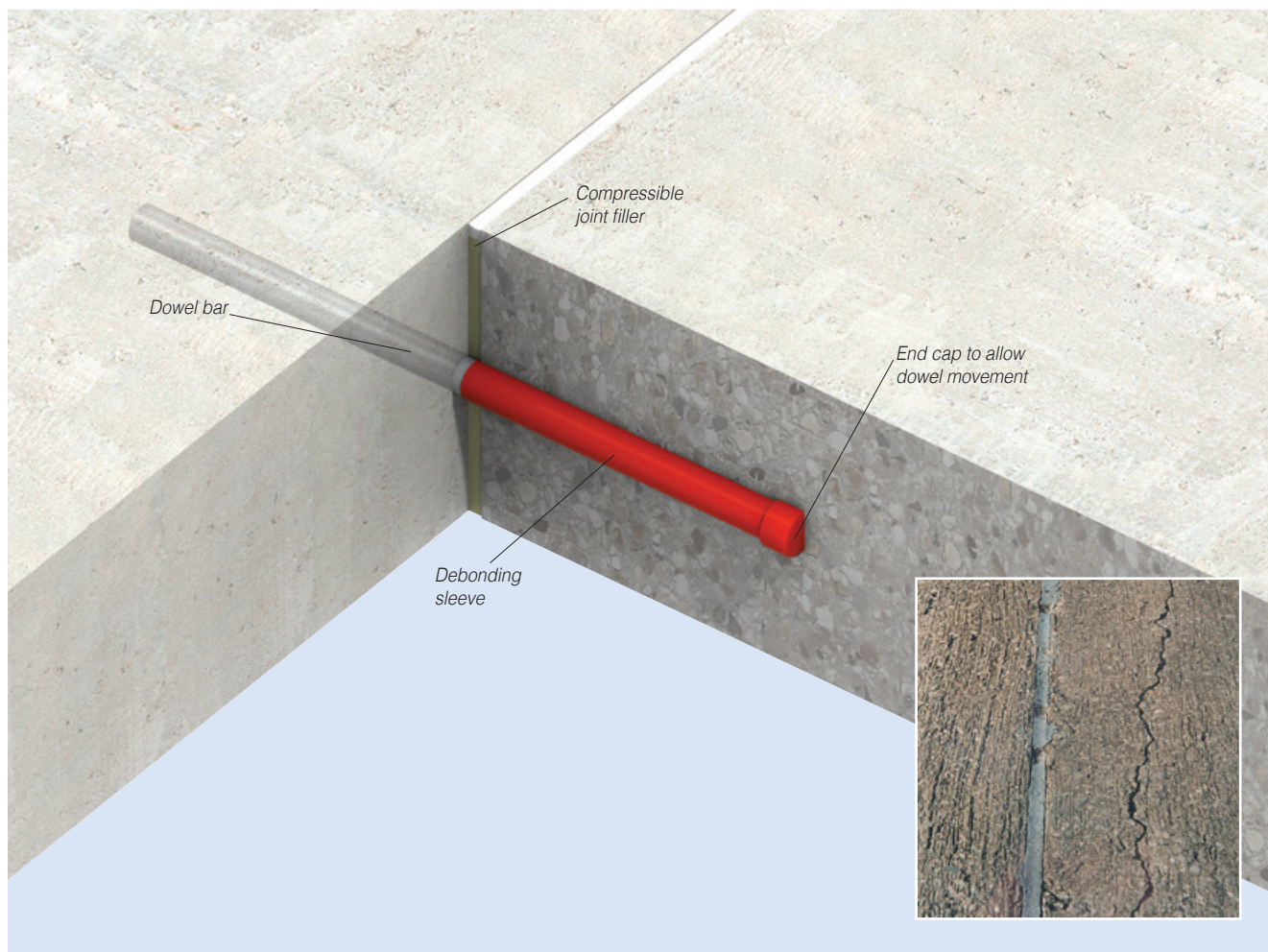
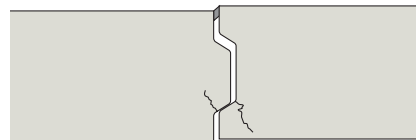

Misaligned dowels can result in cracking away from the expansion joint

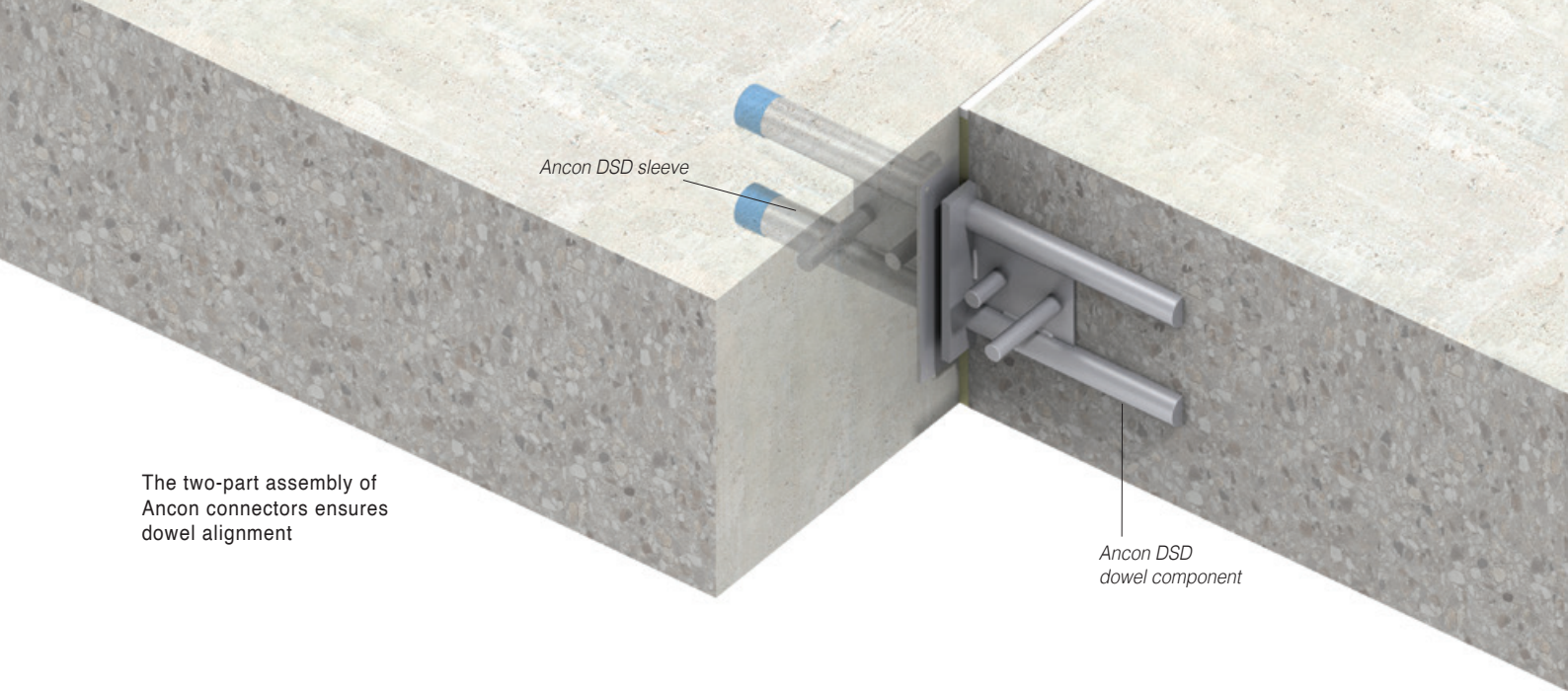

The two-part assembly of Ancon connectors ensures dowel alignment

Conventional Joints
Floor Slab

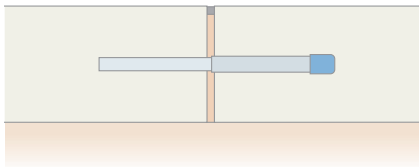

Dowel Bar

Ancon Solutions

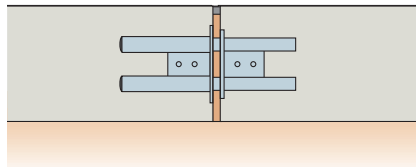

Ancon DSD

Wall

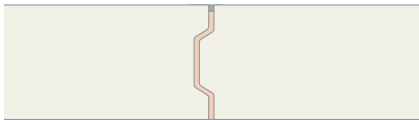

Keyed Joint

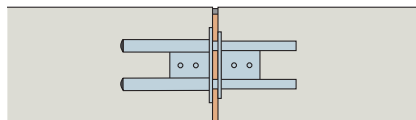

Ancon DSD

Structural Movement Joint

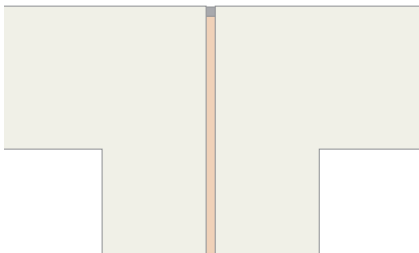

Double Columns

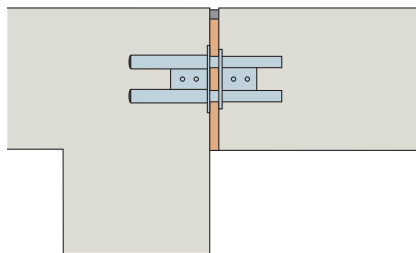

Ancon DSD

Floor to Wall Connection

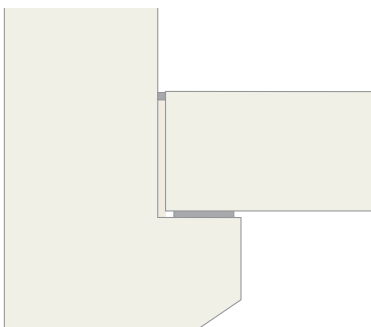

Corbel Support

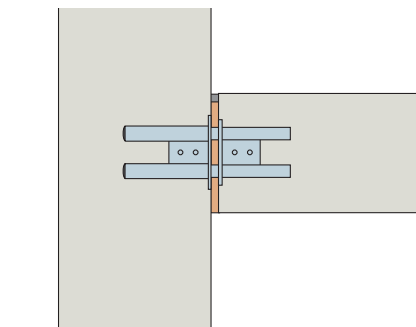

Ancon DSD

Ancon Solutions to Joints

In most cases dowelled or keyed joints can be replaced by joints incorporating Ancon shear load connectors. These connectors are more effective at transferring load and allowing movement to take place, easier to fix on site and can prove a more cost-effective solution.

Ancon connectors can be used for movement joints in floor slabs, suspended slabs, and for replacing double columns and beams at structural movement joints. Applications in civil engineering include joints in bridge parapets, bridge abutments and diaphragm wall construction.

Comparison of Performance with Plain Dowels

400mm Thick Slab with Joint Width of 20mm	One Ancon DSD130	Six 32mm Dia Dowel Bars
Dowel Diameters mm	2 x 35	6 x 32
Area of Dowels mm ²	1924	4825
Design Resistance kN	202.5	197.5

**1 Ancon DSD 130
Design Resistance 202.5kN**

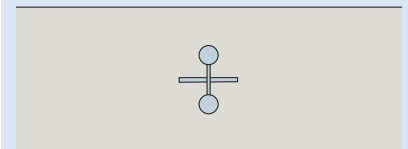

**6 Dowel Bars 32mm Diameter
Design Resistance 197.5kN**

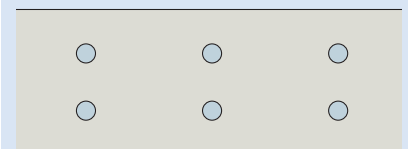

Shear Load Connectors

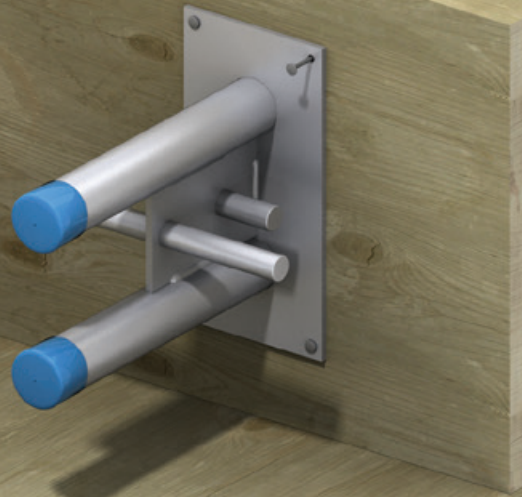

Victoria Point, Melbourne, VIC



Royal Women's Hospital, Melbourne, VIC

There are many applications for Ancon shear connectors in all types of construction using reinforced concrete in both building and civil engineering contracts.

Building Applications

Ground Floor Slabs

Movement joints are usually required to divide a reinforced concrete ground slab into bays. Ancon DSD shear connectors are used to transfer shear load from slab to slab and to prevent differential settlement. Where adjoining bays are different sizes, movement in two directions will occur, Ancon DSDQ shear connectors should be used in this situation.

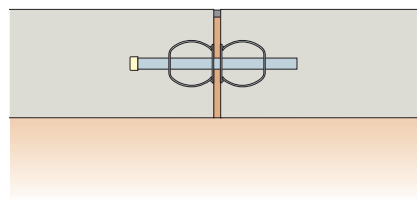

Suspended Floor Slabs

In suspended slabs, connectors should be placed at points of contraflexure where there is little or no bending moment and maximum shear force.

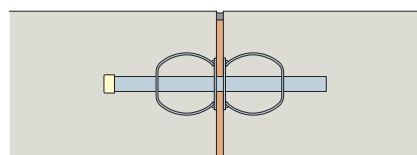

Structural Movement Joints in Frames

A common requirement in framed buildings is a structural movement joint to isolate one part of the building from another. Traditional practice is to provide a line of double columns. The use of Ancon shear connectors reduces costs, speeds construction and increases floor area.

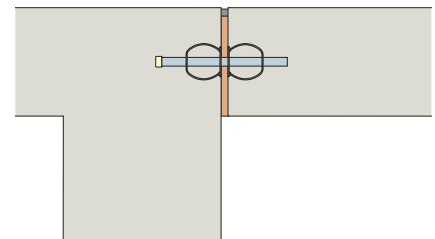

Beam to Wall or Slab Connections

Corbel and half lap joints are a problem to design and difficult and expensive to construct. The use of Ancon DSD shear connectors simplifies design and construction, producing a better detail.

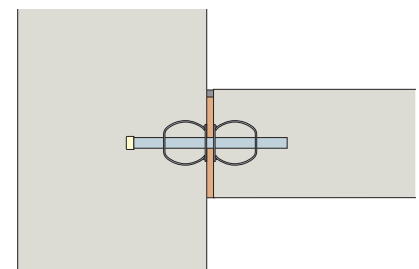

Civil Engineering Applications
Movement Joints in Carriageways

Ancon DSD shear connectors are used in carriageway joints to transfer high shear loads caused by traffic loading and for eliminating differential settlement.

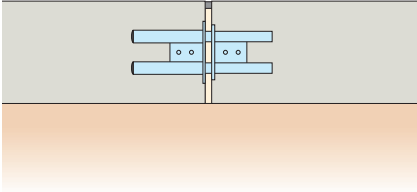

Bridge Abutments

Ancon DSD shear connectors are used vertically at bridge abutments to fix the bridge deck to the abutment. In addition to ease of installation, the use of Ancon DSD shear connectors allows for the bridge deck to be jacked up for bearings to be replaced.

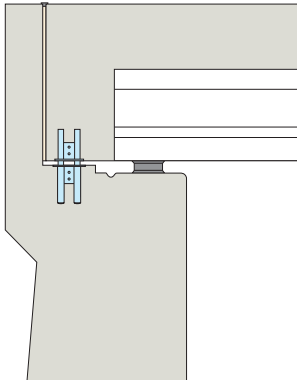

Joints in Parapets

The use of Ancon shear connectors in the vertical joints in parapets is a simple and cost effective way of connecting the sections. The Ancon DSDQ facilitates significant rotation at the joint without reducing the horizontal shear capacity.

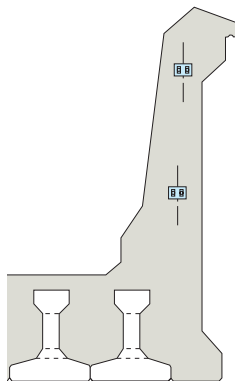

Diaphragm Wall/Slab Connections

Connecting road slabs to diaphragm walls can be a difficult and expensive operation. Forming recesses, or using post fixed dowels into site drilled holes presents many problems on site. Ancon DSD shear connectors provide a cost effective solution. The sleeve components are nailed to plywood formwork which is rigidly fixed to the reinforcement cage. After excavation the plywood is removed to reveal the faces of the sleeves. The dowel components can now be inserted ready to support the slab.

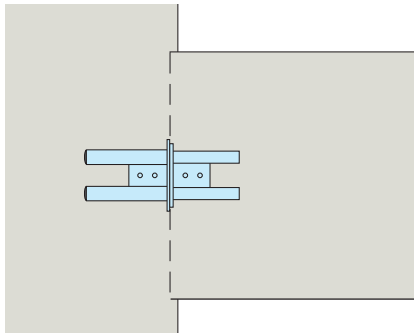

Contiguous Piled Wall/Slab Connections

Similar in application to diaphragm wall construction, Ancon DSD shear connectors are used to transfer shear load from slab to pile.

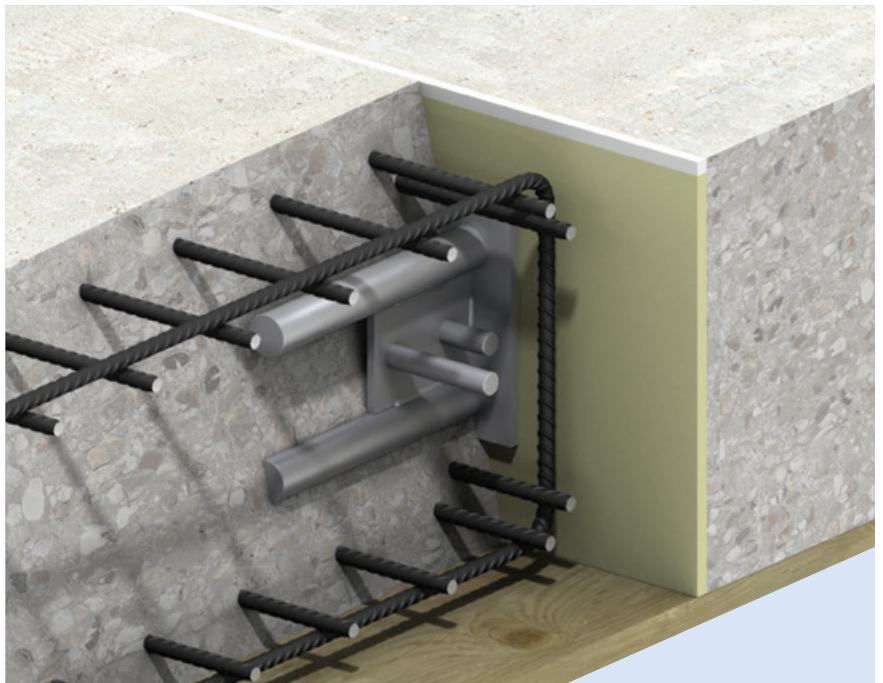
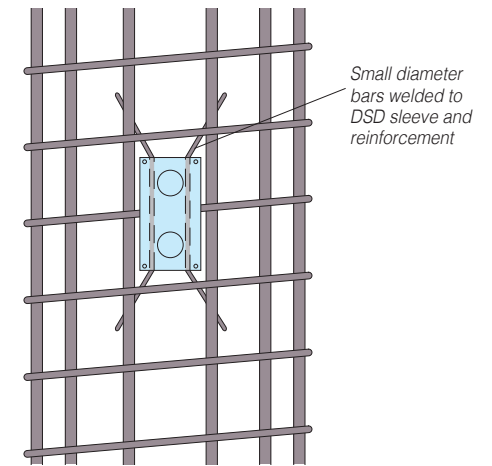
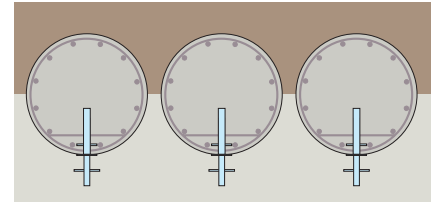

Shear Load Connectors

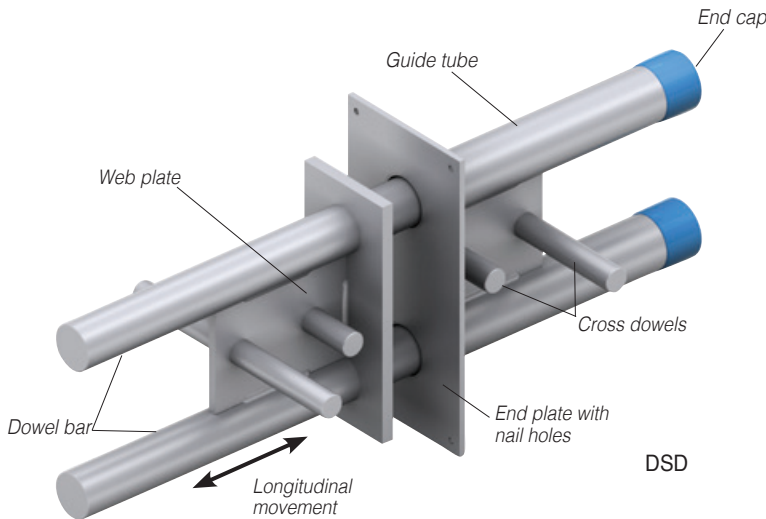

DSD

Ancon Shear Load Connectors

The DSD range of connectors offers significant advantages over plain dowels. Each connector is a two-part assembly comprising a sleeve and a dowel component. Installation is a fast and accurate process, drilling of either formwork or concrete is not required. The sleeve is simply nailed to the formwork ensuring subsequent alignment with the dowel, essential for effective movement.

They are manufactured from stainless steel to ensure a high degree of corrosion resistance with no requirement for additional protection.

Free software is available that simplifies the design of movement joints in reinforced concrete. For a given application, our design program will calculate the size and quantity of shear load connectors required, the edge distance and spacings at which they should be installed, and details of the local reinforcement.

Ancon DSD/Q connectors can be provided with 90 minutes fire protection. Special sleeves, manufactured from a fire barrier material, replace the compressible filler at the connector's position in the joint. This material foams and expands during a fire to protect the connector (page 23).

Ancon DSD

The Ancon DSD is the original two-part, double dowel, shear load connector. The two dowels are Duplex stainless steel bar. The dowel component can move longitudinally within the sleeve to accommodate movement. The connector is available in ten standard sizes and has design resistances from around 20kN to over 950kN. The larger connectors can be used in joints up to 60mm wide. Larger joints can be accommodated using special dowels. Please contact our Technical Department for further information.

Ancon DSDQ

The Ancon DSDQ shear load connector uses the same dowel component as the Ancon DSD, but the cylindrical sleeve is contained within a rectangular box section to allow lateral movement in addition to the longitudinal movement. There are nine standard sizes which have design resistances from around 30kN to over 950kN.

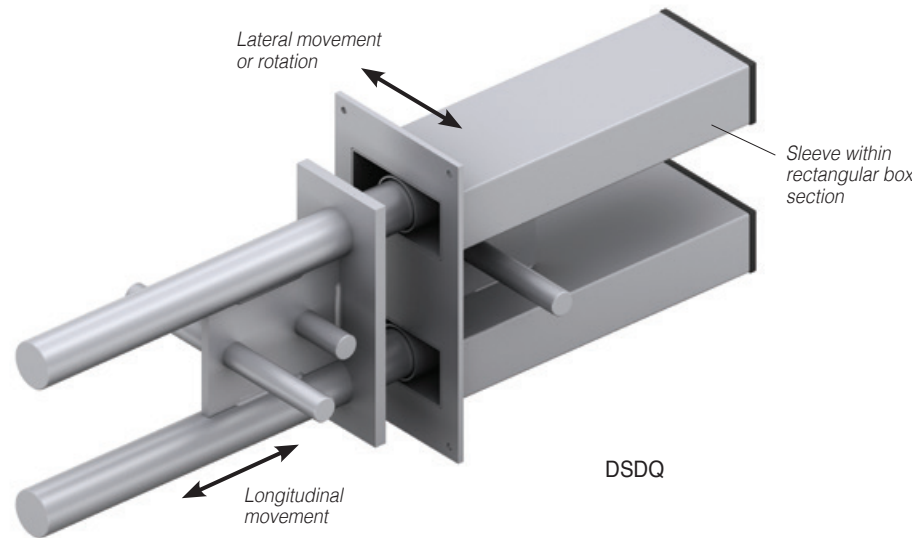

DSDQ

Ancon DSDQ Shear Connectors allowing rotation

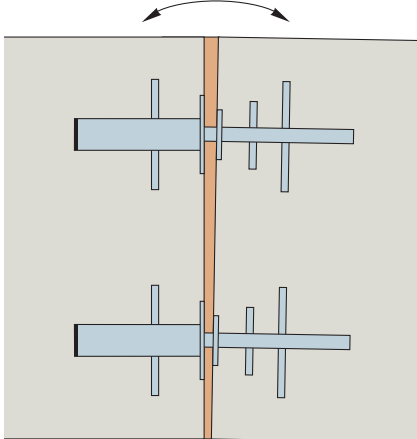

Plan

Ancon DSDQ Shear Connectors allowing movement in two directions

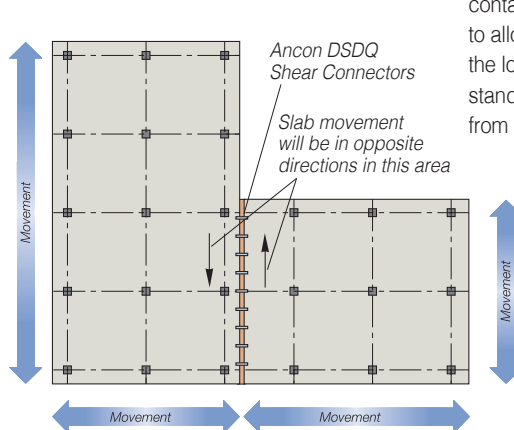

Building Information Modelling

BIM objects of the Ancon DSD and DSDQ are available from www.ancon.com.au

A range of stainless steel single dowel shear connectors is also available.

Ancon ESD

The Ancon ESD shear load connector is used where loads are small, but where alignment is critical. It is available in four sizes. The dowel component is Duplex stainless steel bar.

Ancon ESDQ

The Ancon ESDQ shear load connector uses the same dowel as the ESD, but the cylindrical sleeve is contained within a rectangular box section to allow lateral movement or rotation in addition to longitudinal movement.

Ancon ED

The Ancon ED is a low cost dowel connector for use in floor slabs where alignment is important but loads are small. The single dowel shear connector is available in four sizes. The sleeve component is made from a durable plastic and features an integral nail plate. The dowel component is Duplex stainless steel.

Ancon Staisil-HLD Acoustic Dowel

The Ancon Staisil-HLD features a 22mm diameter stainless steel dowel, located in a sound absorbing sleeve. It is designed to reduce the oscillation of impact sound through a building by isolating concrete components, such as stair landings from the main structural frame. A decoupled concrete configuration, featuring Staisil-HLDs, offers an 18dB impact sound reduction over a rigid concrete floor connection, verified by the Fraunhofer Institute in Germany.

ESDQ-L Lockable Dowel

The ESDQ-L Lockable Dowel allows initial movement to take place and then, after a predetermined time period (generally 90-120 days), is locked with a two-part epoxy resin poured into the L-shaped void former. See page 24 for further information and other products within the range.

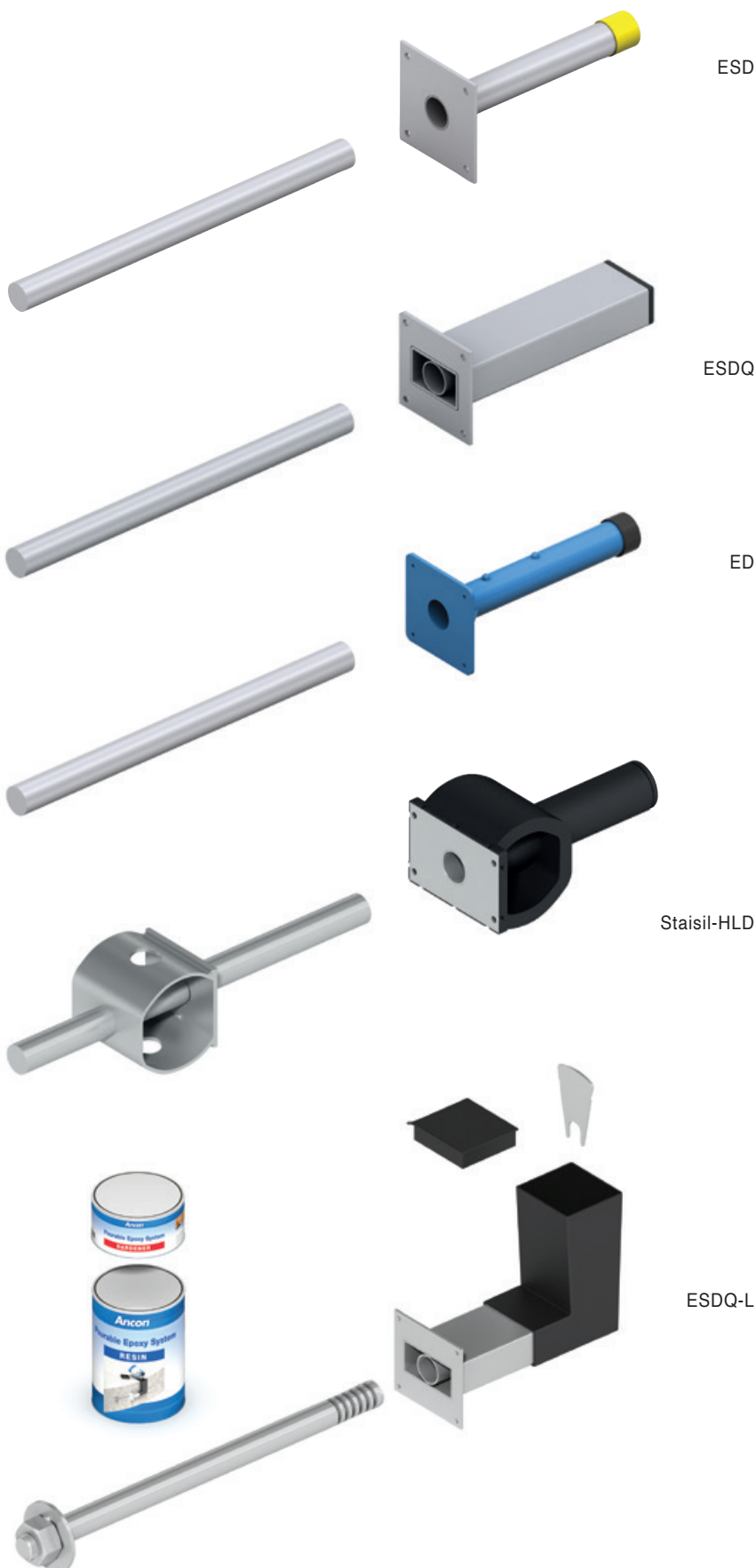

Shear Load Connectors

Installation Procedure

The two-part assembly of all Ancon shear connectors removes the need for drilling formwork on site, supporting dowel bars and fitting debonding sleeves and end caps. The installation is a fast and accurate process.

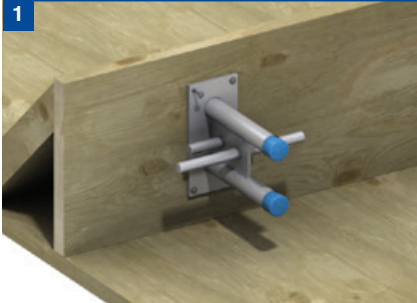
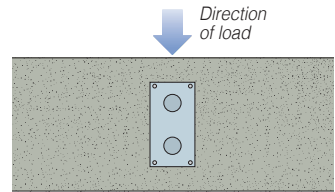

Nail the sleeve component to the shuttering ensuring that the sleeve is correctly orientated for the direction of the load. Check that the minimum spacing and edge distances are not exceeded. The label prevents debris from entering into the sleeve aperture and should not be removed at this stage.

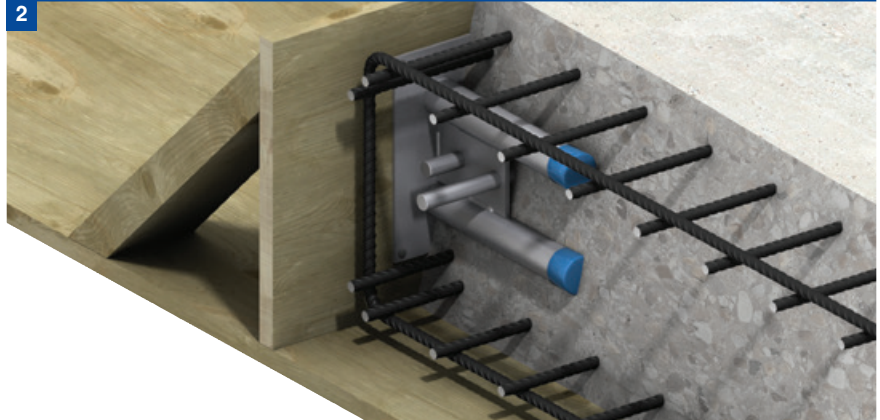

Fix the local reinforcement in position around the sleeve component together with any other reinforcement that is required, ensuring that the correct cover to the reinforcement is maintained. Pour the concrete to complete the installation of the sleeve component.



When the concrete has achieved sufficient strength, strike the shuttering. Peel off or puncture the label to reveal the holes for the dowels. Where 'Q' versions are being used, the label should only be punctured enough to allow the dowel into the cylindrical sleeve to prevent debris entering the box section.



Position compressible joint filler of the appropriate width, for applications where movement is expected between the two sections of concrete.



Push the dowel component through the joint filler (if applicable) until it is fully located in the sleeve component. It may be necessary to tap the dowel component to overcome the dimple which pinch holds the dowel in the sleeve and prevents dislocation when the concrete is vibrated.



Fix the local reinforcement in position around the dowel component together with any other reinforcement that is required, ensuring that the correct cover to the reinforcement is maintained. Pour the concrete to complete the installation of the shear connector.

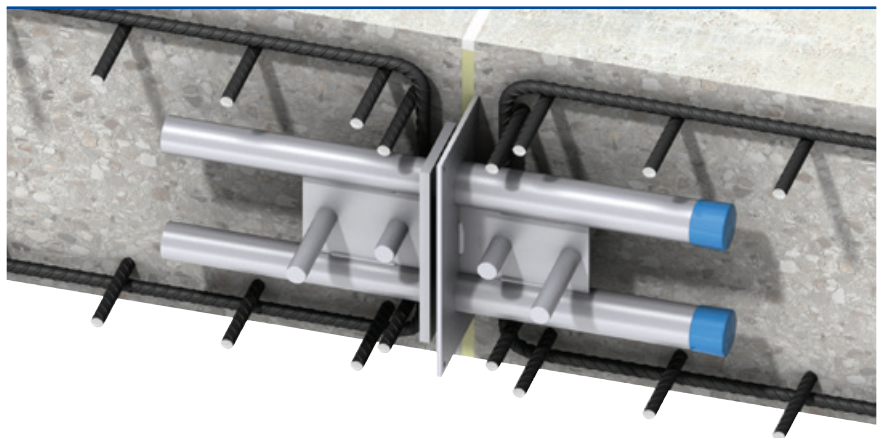

Notes:

- (i) Although installation is shown for Ancon DSD, the procedure is the same for all Ancon shear connectors.
- (ii) Where deep concrete pours are proposed, the installation will require further consideration. More robust fixing of the sleeve and dowel components will be necessary to avoid displacement during placing of the concrete.



Design Resistance

Ancon DSD V_{Rd} Design Resistance (kN) for Various Joint Widths (mm) at the Maximum Slab Thickness (mm) in 32 MPa Concrete

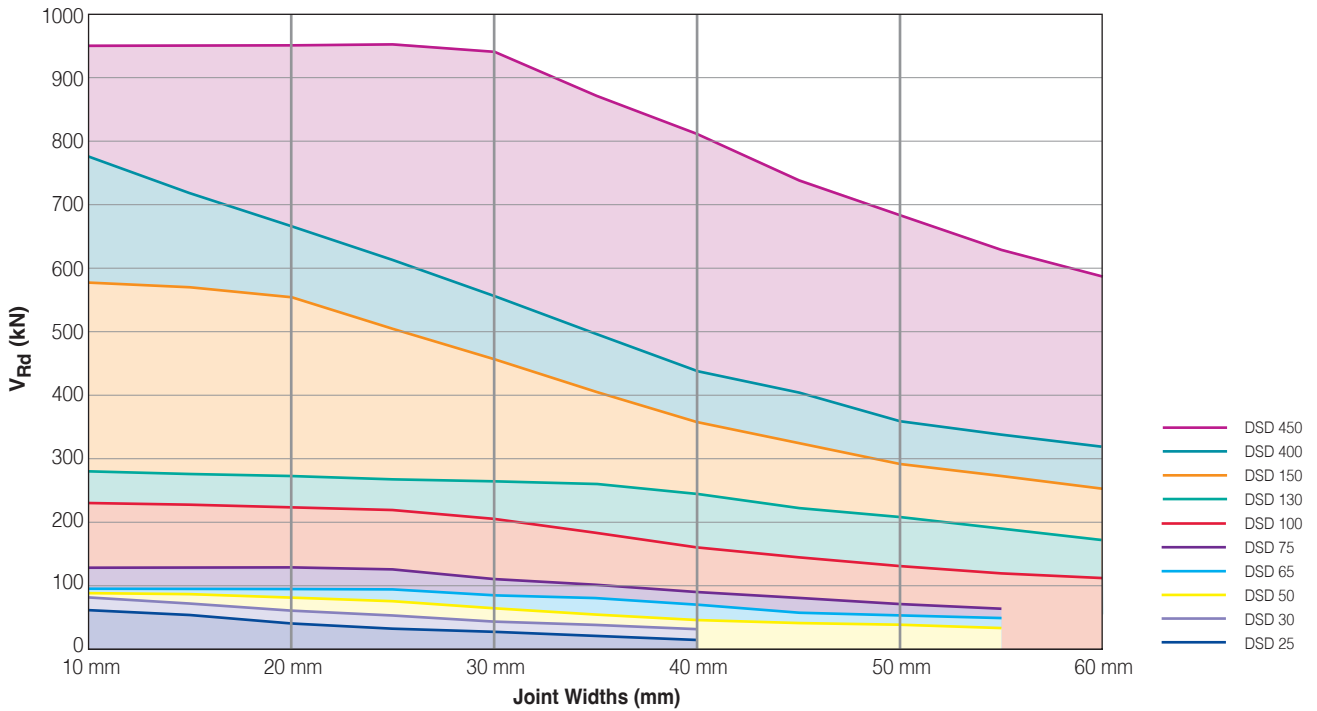

Note: For more detailed information please see page 15.

Ancon ESD V_{Rd} Design Resistance (kN) for Various Joint Widths (mm) at the Maximum Slab Thickness (mm) in 32 MPa Concrete

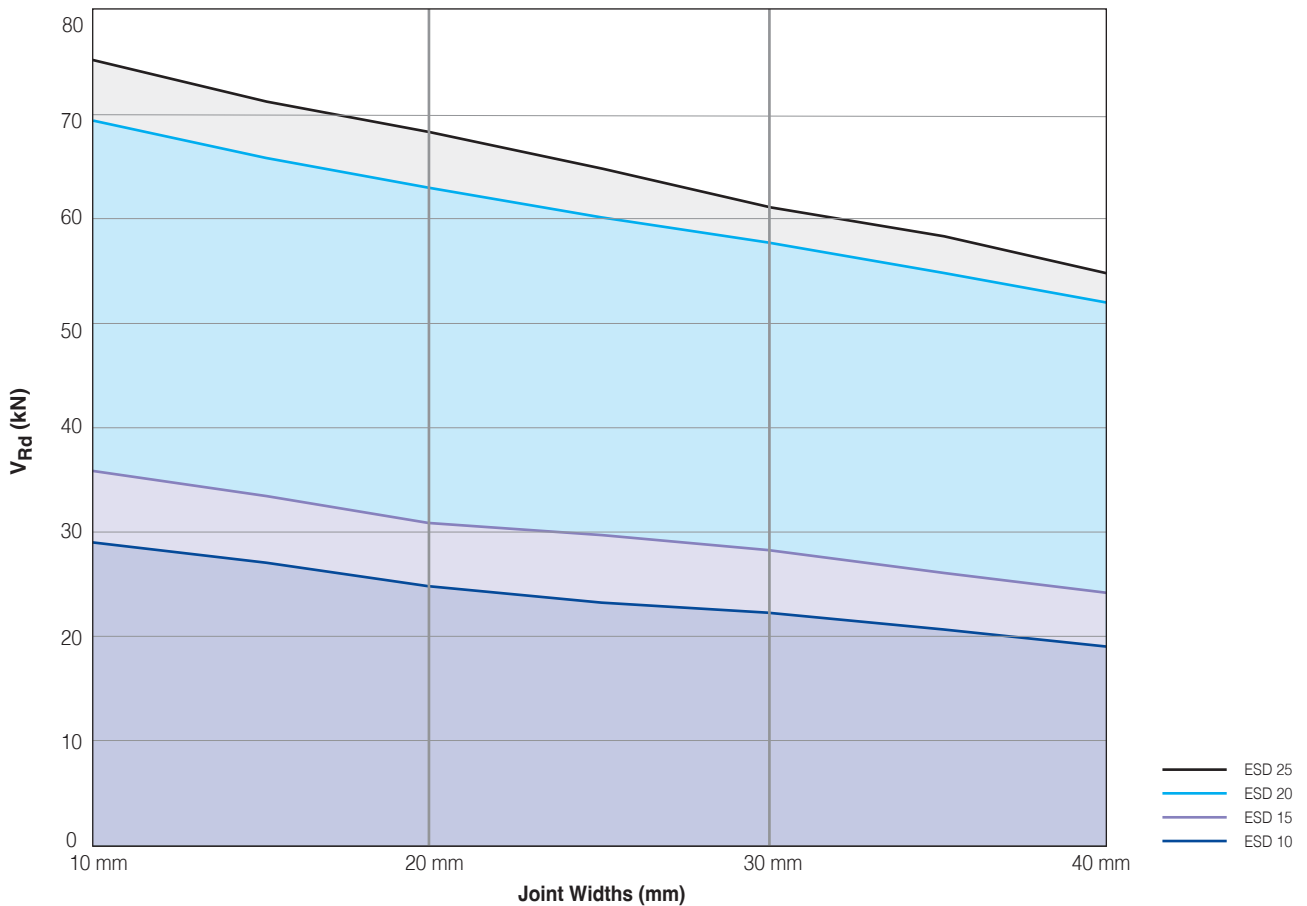

Note: For more detailed information please see page 21.

Shear Load Connectors

DSD and DSDQ Shear Connectors

V_{Rd} Design Resistance (kN) for Various Joint Widths (mm) and Slab Thickness (mm) using 25MPa Concrete

Slab Thickness (mm)	Product Reference	Maximum Width of Joint (mm)					
		10	20	30	40	50	60
180*	DSD 25	39.5	39.5	29.9	23.2	-	-
200		45.7	41.8	29.9	23.2	-	-
220		52.3	41.8	29.9	23.2	-	-
240		59.3	41.8	29.9	23.2	-	-
260		66.7	41.8	29.9	23.2	-	-
280		69.6	41.8	29.9	23.2	-	-
180*	DSD/DSDQ 30	42.7	42.7	42.7	34.7	-	-
200		49.2	49.2	44.6	34.7	-	-
220		56.1	56.1	44.6	34.7	-	-
240		63.4	62.4	44.6	34.7	-	-
260		71.1	62.4	44.6	34.7	-	-
280		79.1	62.4	44.6	34.7	-	-
180*	DSD/DSDQ 50	43.8	43.8	43.8	43.8	40.4	-
200		50.3	50.3	50.3	49.4	40.4	-
220		57.3	57.3	57.3	49.4	40.4	-
240		64.6	64.6	63.5	49.4	40.4	-
260		72.3	72.3	63.5	49.4	40.4	-
280		80.4	80.4	63.5	49.4	40.4	-
200*	DSD/DSDQ 65	62.2	62.2	62.2	62.2	55.4	-
220		64.3	64.3	64.3	64.3	55.4	-
240		68.6	68.6	68.6	67.7	55.4	-
260		76.4	76.4	76.4	67.7	55.4	-
280		84.6	84.6	84.6	67.7	55.4	-
300		93.0	93.0	87.1	67.7	55.4	-
240*	DSD/DSDQ 75	86.1	86.1	86.1	86.1	73.8	-
260		89.1	89.1	89.1	89.1	73.8	-
280		94.8	94.8	94.8	90.1	73.8	-
300		104.0	104.0	104.0	90.1	73.8	-
320		113.6	113.6	113.6	90.1	73.8	-
340		123.4	123.4	115.9	90.1	73.8	-
320*	DSD/DSDQ 100	161.5	157.6	154.0	150.5	133.6	114.0
340		166.5	162.6	158.8	155.2	133.6	114.0
360		170.8	166.7	162.8	159.1	133.6	114.0
380		183.2	178.9	174.7	161.4	133.6	114.0
400		196.0	191.4	186.9	161.4	133.6	114.0
420		209.1	204.2	199.4	161.4	133.6	114.0
360*	DSD/DSDQ 130	185.0	181.3	177.7	174.3	171.0	167.9
380		193.4	189.5	185.8	182.2	178.8	175.5
400		206.6	202.5	198.5	194.7	191.0	176.1
420		220.2	215.8	211.5	207.5	203.6	176.1
440		234.0	229.3	224.8	220.5	206.5	176.1
460		248.2	243.2	238.4	233.8	206.5	176.1
450*	DSD/DSDQ 150	280.8	276.0	271.3	266.8	262.4	253.6
500		308.2	302.8	297.7	292.8	288.0	253.6
550		339.7	333.8	328.2	322.7	297.4	253.6
600		380.5	373.9	367.6	359.3	297.4	253.6
700		465.4	457.3	449.6	359.3	297.4	253.6
800		485.6	477.2	451.2	359.3	297.4	253.6
600*	DSD/DSDQ 400	441.1	434.6	428.3	422.2	369.3	315.0
650		485.1	478.0	471.0	441.8	369.3	315.0
700		529.9	522.1	514.5	441.8	369.3	315.0
800		620.9	611.8	554.1	441.8	369.3	315.0
900		712.7	666.4	554.1	441.8	369.3	315.0
1000		745.3	666.4	554.1	441.8	369.3	315.0
600*	DSD/DSDQ 450	485.1	485.1	485.1	485.1	485.1	485.1
650		515.5	515.5	515.5	515.5	515.5	515.5
700		561.4	561.4	561.4	561.4	561.4	561.4
800		654.4	654.4	654.4	654.4	654.4	586.9
900		747.9	747.9	747.9	747.9	684.7	586.9
1000		840.1	840.1	840.1	811.4	684.7	586.9

* Refers to the minimum slab depth H_{min} for each connector type.

Position of connectors in slab

The tables on pages 14 and 15 are based on the shear connector being located centrally in the slab edge. If the shear connector is offset from the centreline, the minimum distance between the connector centre and the slab face should be considered as $H/2$.

$$H=2 \times \min(A,B)$$

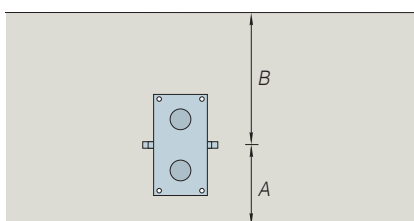

$A < B$
Slab thickness to be considered in selecting the connector is $2 \times A$. Minimum values are shown in the table.

Product Reference	Minimum Slab Depth H_{min}	Minimum Depth 'A'
DSD 25	180mm	90mm
DSD/DSDQ 30	180mm	90mm
DSD/DSDQ 50	180mm	90mm
DSD/DSDQ 65	200mm	100mm
DSD/DSDQ 75	240mm	120mm
DSD/DSDQ 100	320mm	160mm
DSD/DSDQ 130	360mm	180mm
DSD/DSDQ 150	450mm	225mm
DSD/DSDQ 400	600mm	300mm
DSD/DSDQ 450	600mm	300mm

DSD and DSDQ Shear Connectors

V_{Rd} Design Resistance (kN) for Various Joint Widths (mm) and Slab Thickness (mm) using 32MPa Concrete

Slab Thickness (mm)	Product Reference	Maximum Width of Joint (mm)					
		10	20	30	40	50	60
180*	DSD 25	44.7	41.8	29.9	23.2	-	-
200		51.8	41.8	29.9	23.2	-	-
220		59.3	41.8	29.9	23.2	-	-
240		67.3	41.8	29.9	23.2	-	-
260		69.6	41.8	29.9	23.2	-	-
280		69.6	41.8	29.9	23.2	-	-
180*	DSD/DSDQ 30	48.3	48.3	44.6	34.7	-	-
200		55.7	55.7	44.6	34.7	-	-
220		63.6	62.4	44.6	34.7	-	-
240		71.8	62.4	44.6	34.7	-	-
260		80.5	62.4	44.6	34.7	-	-
280		89.7	62.4	44.6	34.7	-	-
180*	DSD/DSDQ 50	49.6	49.6	49.6	49.4	40.4	-
200		57.0	57.0	57.0	49.4	40.4	-
220		64.9	64.9	63.5	49.4	40.4	-
240		73.2	73.2	63.5	49.4	40.4	-
260		82.0	82.0	63.5	49.4	40.4	-
280		91.1	88.9	63.5	49.4	40.4	-
200*	DSD/DSDQ 65	70.5	70.5	70.5	67.7	55.4	-
220		72.8	72.8	72.8	67.7	55.4	-
240		77.8	77.8	77.8	67.7	55.4	-
260		86.6	86.6	86.6	67.7	55.4	-
280		95.8	95.8	87.1	67.7	55.4	-
300		105.5	105.5	87.1	67.7	55.4	-
240*	DSD/DSDQ 75	97.6	97.6	97.6	90.1	73.8	-
260		101.0	101.0	101.0	90.1	73.8	-
280		107.4	107.4	107.4	90.1	73.8	-
300		117.9	117.9	115.9	90.1	73.8	-
320		128.7	128.7	115.9	90.1	73.8	-
340		139.9	139.9	115.9	90.1	73.8	-
320*	DSD/DSDQ 100	183.0	178.7	174.5	161.4	133.6	114.0
340		188.7	184.3	180.0	161.4	133.6	114.0
360		193.5	188.9	184.5	161.4	133.6	114.0
380		207.7	202.7	198.0	161.4	133.6	114.0
400		222.2	216.9	203.9	161.4	133.6	114.0
420		237.0	231.4	203.9	161.4	133.6	114.0
360*	DSD/DSDQ 130	209.7	205.5	201.4	197.6	193.8	176.1
380		219.2	214.8	210.6	206.5	202.7	176.1
400		234.2	229.5	225.0	220.7	206.5	176.1
420		249.5	244.5	239.8	235.1	206.5	176.1
440		265.2	259.9	254.8	249.5	206.5	176.1
460		281.2	275.6	270.2	249.5	206.5	176.1
450*	DSD/DSDQ 150	318.2	312.8	307.5	302.3	297.4	253.6
500		349.2	343.2	337.4	331.8	297.4	253.6
550		385.0	378.3	371.9	359.3	297.4	253.6
600		431.2	423.8	416.6	359.3	297.4	253.6
700		527.4	518.3	451.2	359.3	297.4	253.6
800		582.7	553.0	451.2	359.3	297.4	253.6
600*	DSD/DSDQ 400	499.9	492.5	485.4	441.8	369.3	315.0
650		549.8	541.7	533.8	441.8	369.3	315.0
700		600.5	591.7	554.1	441.8	369.3	315.0
800		703.7	666.4	554.1	441.8	369.3	315.0
900		778.7	666.4	554.1	441.8	369.3	315.0
1000		778.7	666.4	554.1	441.8	369.3	315.0
600*	DSD/DSDQ 450	549.8	549.8	549.8	549.8	549.8	549.8
650		584.2	584.2	584.2	584.2	584.2	584.2
700		636.2	636.2	636.2	636.2	636.2	586.9
800		741.7	741.7	741.7	741.7	684.7	586.9
900		847.6	847.6	847.6	811.4	684.7	586.9
1000		952.1	952.1	941.1	811.4	684.7	586.9

* Refers to the minimum slab depth H_{min} for each connector type.

DSD Design Example

Slab thickness	= 400mm	
Joint width	= 30mm	
Concrete strength	= 32MPa	
Characteristic dead load	= 100kN/m	$\gamma_G = 1.2^*$
Characteristic imposed load	= 120kN/m	$\gamma_Q = 1.5^*$
Design load	= $(100 \times 1.2) + (120 \times 1.5) = 300\text{kN/m}$	

F_{Rd} (Design capacity)	Maximum centres	<i>Either connector would be acceptable, although using DSD100s at 600mm centres would be the most cost-effective solution.</i>
DSD100 = 203.9kN	= $203.9 / 300 = 0.679\text{m}$ use 600mm	
DSD130 = 225.0kN	= $225.0 / 300 = 0.750\text{m}$ use 700mm	

*The partial safety factors of 1.2 (γ_G) and 1.5 (γ_Q) are those recommended in AS 1170 Structural Design Actions.

See local reinforcement requirements on page 16.

Shear Load Connectors

DSD Reinforcement Details

Local reinforcement is required around each connector to guarantee that the forces are transferred between the connectors and the concrete. Correct detailing in accordance with appropriate design codes and the recommendations provided here will ensure Ancon DSD and DSDQ connectors attain their full capacity.

The tables show proposals for the type and spacing of the main reinforcement, together with details of reinforcement above and below the connectors (top and bottom bars).

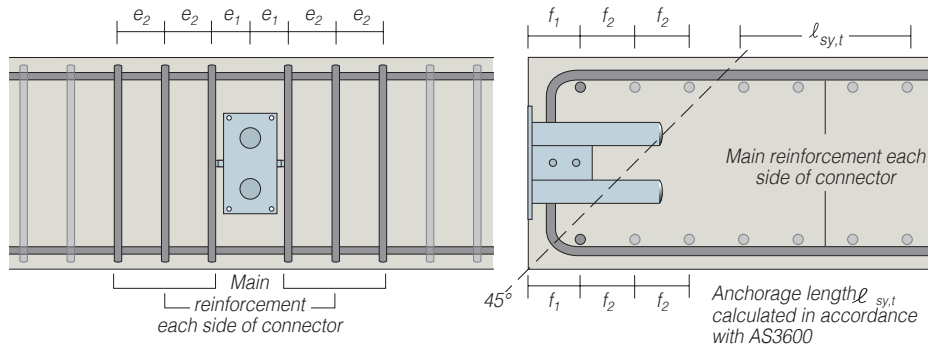

Based on 32MPa Concrete, maximum slab depth (see page 15) 20mm joint and 30mm cover

DSD/DSDQ	Options for Main Reinforcement (No. U bars each side)		Maximum Spacing (mm)
	DSD/DSDQ	U bars	
25*	2 N10	$e_1 = 50\text{mm}; e_2 = 90\text{mm}$	
30	3 N10	$e_1 = 50\text{mm}; e_2 = 50\text{mm}$	
50	2 N12	$e_1 = 50\text{mm}; e_2 = 90\text{mm}$	
65	4 N10	$e_1 = 50\text{mm}; e_2 = 30\text{mm}$	
	3 N12	$e_1 = 50\text{mm}; e_2 = 40\text{mm}$	
75	4 N10	$e_1 = 60\text{mm}; e_2 = 40\text{mm}$	
	3 N12	$e_1 = 60\text{mm}; e_2 = 56\text{mm}$	
100	5 N10	$e_1 = 60\text{mm}; e_2 = 40\text{mm}$	
	4 N12	$e_1 = 60\text{mm}; e_2 = 50\text{mm}$	
130	5 N12	$e_1 = 60\text{mm}; e_2 = 50\text{mm}$	
	3 N16	$e_1 = 60\text{mm}; e_2 = 100\text{mm}$	
150	4 N16	$e_1 = 60\text{mm}; e_2 = 80\text{mm}$	
	6 N16	$e_1 = 60\text{mm}; e_2 = 100\text{mm}$	
400	7 N16	$e_1 = 60\text{mm}; e_2 = 110\text{mm}$	
	5 N20	$e_1 = 60\text{mm}; e_2 = 160\text{mm}$	
450	9 N16	$e_1 = 60\text{mm}; e_2 = 80\text{mm}$	
	7 N20	$e_1 = 60\text{mm}; e_2 = 110\text{mm}$	



DSD/DSDQ	Options for Longitudinal Bars (No. bars top and bottom)		Spacing (mm)
	DSD/DSDQ	Longitudinal Bars	
25*	1 N10	$f_1 = 60\text{mm}; f_2 = \text{NA}$	
30	2 N10	$f_1 = 60\text{mm}; f_2 = 60\text{mm}$	
50	2 N10	$f_1 = 60\text{mm}; f_2 = 70\text{mm}$	
65	2 N10	$f_1 = 60\text{mm}; f_2 = 70\text{mm}$	
75	3 N10	$f_1 = 60\text{mm}; f_2 = 70\text{mm}$	
	2 N12	$f_1 = 60\text{mm}; f_2 = 70\text{mm}$	
100	3 N12	$f_1 = 60\text{mm}; f_2 = 70\text{mm}$	
	2 N16	$f_1 = 60\text{mm}; f_2 = 70\text{mm}$	
130	4 N12	$f_1 = 60\text{mm}; f_2 = 70\text{mm}$	
	2 N16	$f_1 = 60\text{mm}; f_2 = 70\text{mm}$	
150	4 N16	$f_1 = 60\text{mm}; f_2 = 70\text{mm}$	
400	5 N16	$f_1 = 60\text{mm}; f_2 = 100\text{mm}$	
450	6 N16	$f_1 = 60\text{mm}; f_2 = 100\text{mm}$	

*DSD only

For walls, the reinforcement is repeated as in the tables but with links replacing the U-bars. Links should extend between the near face and the far face of the wall reinforcement.

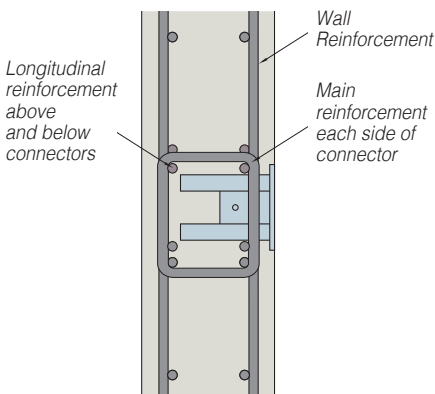

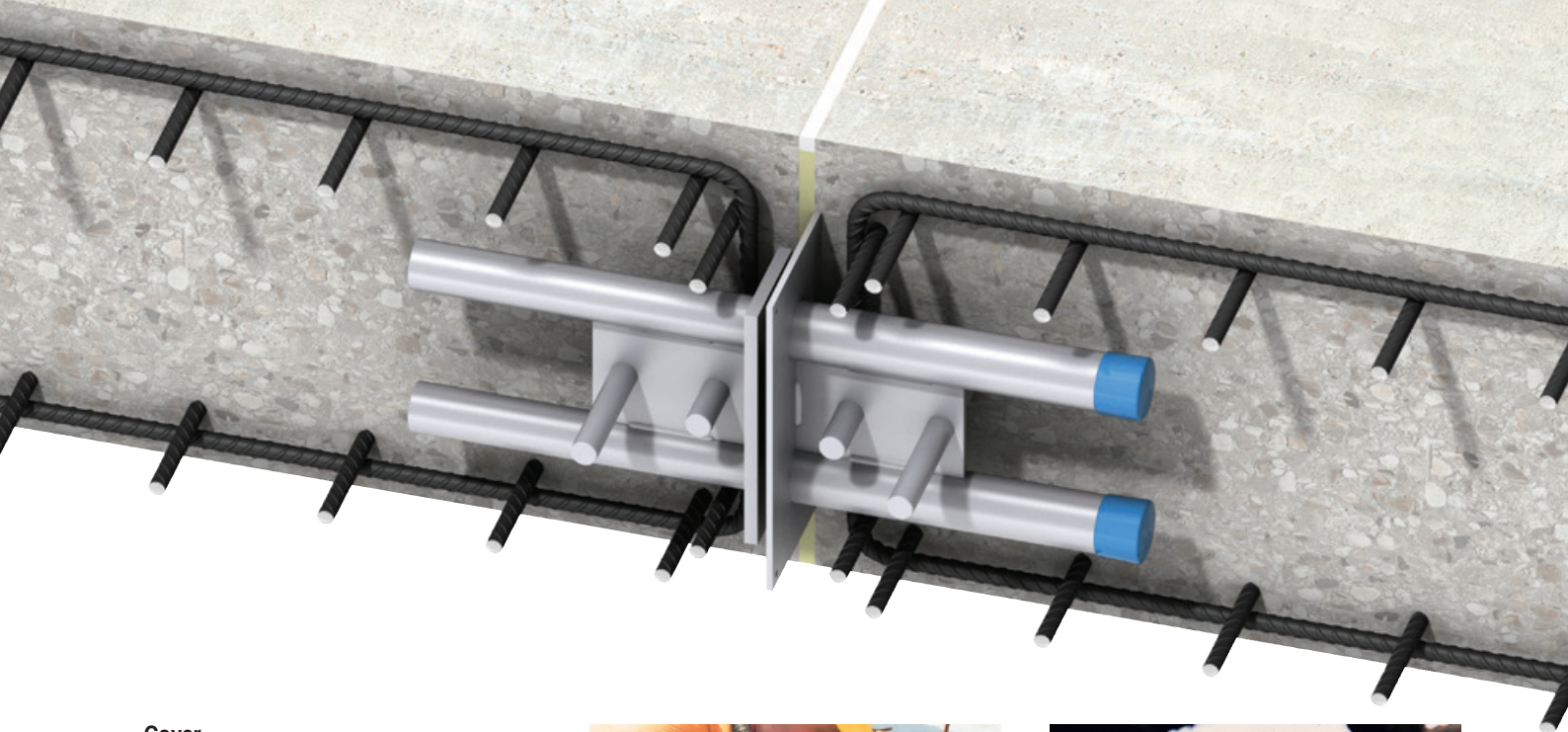

Cover

Minimum cover to local reinforcement is to the recommendations of AS 3600: 2009 (Table 4.10.3.2). Maximum cover is as shown in the table.

Ref DSD DSDQ	Max Cover to Face (mm)
25*	30
30	30
50	30
65	40
75	50
100	50
130	50
150	50
400	60
450	60

* DSD only

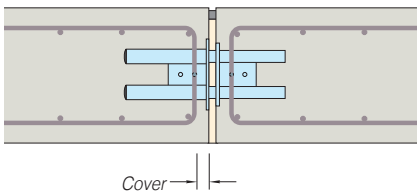

Minimum Wall Thickness

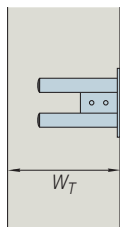

Ref DSD/DSDQ	Minimum Wall Thickness W_T DSD	DSDQ
25	180mm	-
30	180mm	190mm
50	185mm	210mm
65	205mm	225mm
75	205mm	225mm
100	260mm	290mm
130	315mm	340mm
150	325mm	355mm
400	385mm	405mm
450	420mm	455mm

Guidance on Specifying DSD at Beam Connections

The diagram and table show the minimum vertical and horizontal dowel spacings. For further guidance, and local reinforcement requirements, please contact us.

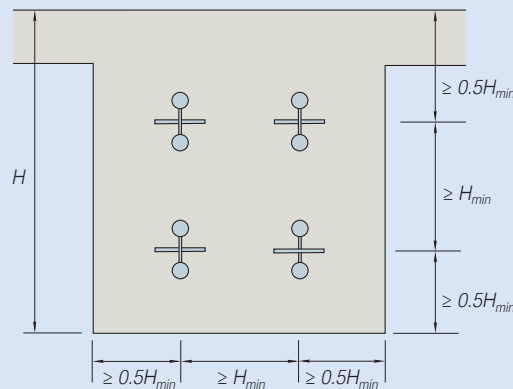

Minimum Dowel Centres

DSD Type	H_{min}
DSD25	180mm
DSD30	180mm
DSD50	180mm
DSD65	200mm
DSD75	240mm
DSD100	320mm
DSD130	360mm
DSD150	450mm
DSD400	600mm
DSD450	600mm

Shear Load Connectors

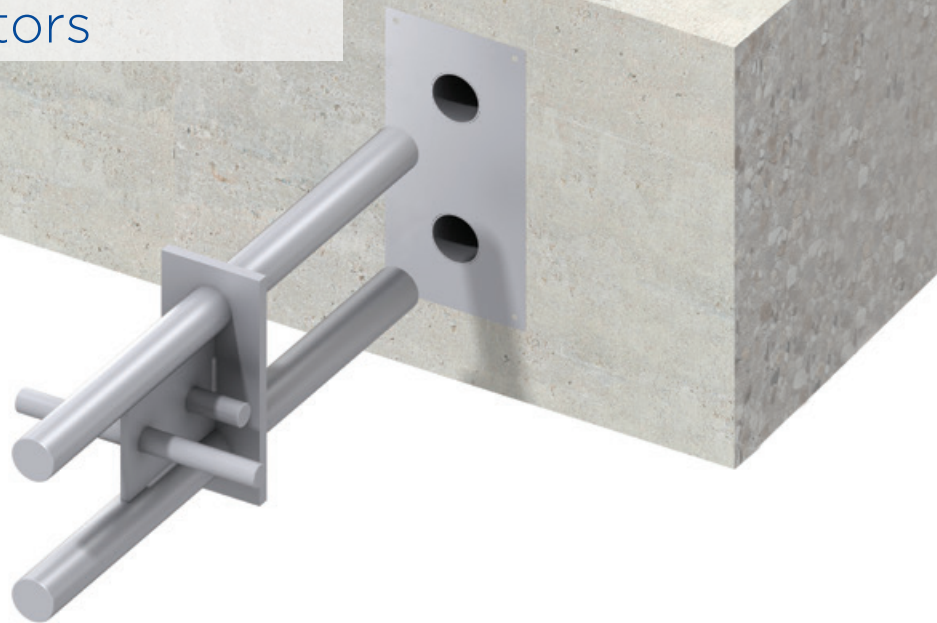

Dowel Component

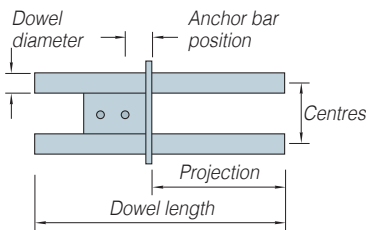

DSD Sleeve

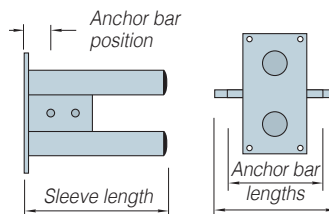

DSDQ Sleeve

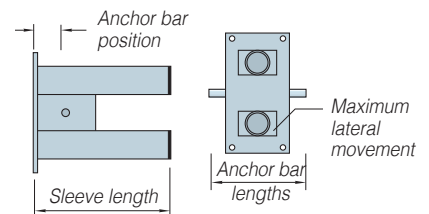

Dimensions

Ref DSD DSDQ	Dowel Component					DSD Sleeve			DSDQ Sleeve			Lateral Mov't	
	Dowel Length	Dowel Dia	Dowel Centres	Dowel Projection	Anchor Bar Position	Anchor Bar Lengths	Sleeve Length	Anchor Bar Position	Anchor Bar Lengths	Sleeve Length	Anchor Bar Position		Anchor Bar Length
25*	250	14	40	120	31	50/110	120	28	50/110	-	-	-	-
30	260	16	48	120	31	50/110	120	28	50/110	140	33	70	+/-12.5
50	280	18	50	130	31	50/130	135	28	50/130	160	33	70	+/-12.8
65	300	20	65	150	31	50/130	155	28	50/130	175	33	70	+/-10.5
75	340	22	75	150	33	50/150	155	31	50/150	175	33	120	+/-10.3
100	400	30	100	210	34	80/170	210	36	80/170	240	54	170	+/-20.75
130	470	35	105	260	34	80/170	265	36	80/170	290	59	170	+/-18.25
150	550	42	120	270	54	80/210	275	39	80/210	305	54	170	+/-10.85
400	660	52	160	330	70	130/300	335	70	130/300	355	64	300	+/-15.25
450	690	65	180	360	80	130/300	370	80	130/300	400	89	300	+/-27.5

Notes: *DSD only. All dimensions are in millimetres (mm).

Edge Distance and Spacing

The minimum edge distance and spacing of Ancon DSD/DSDQ shear load connectors is determined by the depth of slab and is illustrated in the adjacent drawing. It is possible to reduce the spacing further with the absolute minimum being $1.5 H_{\min}$ (where H_{\min} is the minimum slab depth for each connector type), however the design resistances are then limited to those given for H_{\min} .

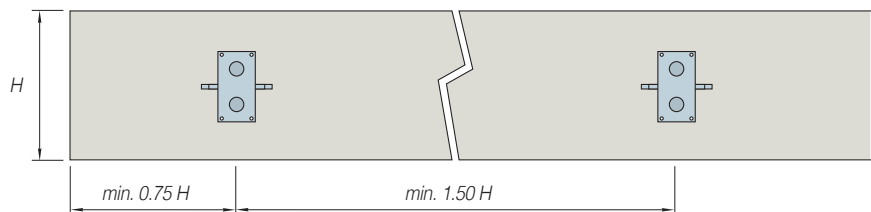

Example

Slab thickness	= 420mm
Joint width	= 30mm
Concrete strength	= 32MPa
Design load per connector	= 203.9 kN
Spacing for max. load	= $420 \times 1.5 = 630\text{mm}$
End distance for max. load	= $420 \times 0.75 = 315\text{mm}$
Design capacity per metre	= 323.65kN/m

As a DSD100 can be used in a 320mm slab for a design load per connector of up to 178.7kN, the spacing can be based on a 320mm slab. Therefore:

Reduced spacing	= $320 \times 1.5 = 480\text{mm}$
Reduced end distance	= $320 \times 0.75 = 240\text{mm}$
Design capacity per metre	= $174.5 / 0.48 = 363.54\text{kN/m}$

DSD100 Design Capacities for 30mm Joints in 32MPa Concrete

Slab Thickness	Design Capacity
320mm	174.5kN
340mm	180.0kN
360mm	184.5kN
380mm	198.0kN
400mm	203.9kN
420mm	203.9kN

Ancon ESD/Q Dimensions

Dowel Component

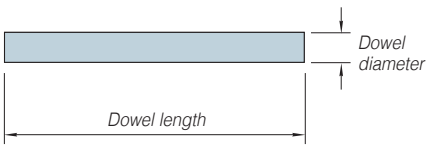

ESD Sleeve

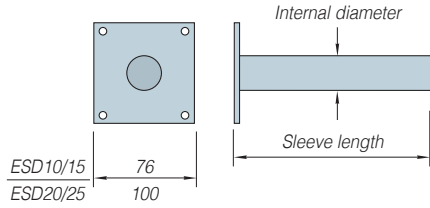

ESDQ Sleeve

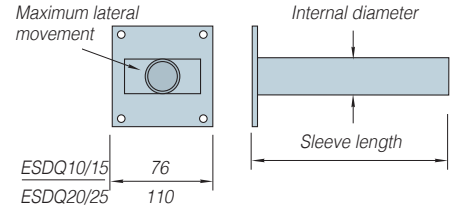

Ref	Dowel Component		ESD Sleeve		ESDQ Sleeve				
	ESD	ESDQ	Dowel Diameter	Dowel Length	Internal Diameter	Sleeve Length	Internal Diameter	Sleeve Length	Max. Lateral Movement
10 300			20	300	21	175	21	175	+/-10
15 300			22	300	23	175	23	175	+/-10
20 300			30	300	31	175	31	175	+/-20.5
25 350			35	350	36	200	36	200	+/-18

Notes: Example Ref ESD10 300. All dimensions are in millimetres (mm).

Ancon ED Dimensions

The dowel component is available in Duplex stainless steel, zinc plated and carbon steel.

Dowel Component

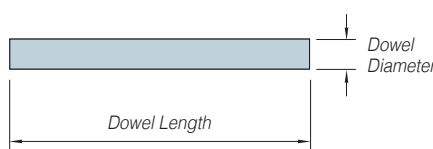

ED Sleeve

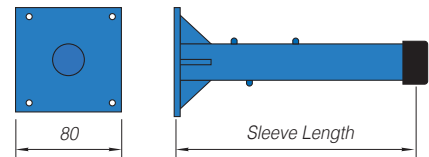

Ref	Dimensions			
	ED	Dowel Diameter	Dowel Length	Sleeve Length
10 300		20	300	170
15 300		22	300	170
20 300		30	300	170
25 350		35	350	195

Notes: Example Ref ED10 300. All dimensions are in millimetres (mm).

Edge Distance and Spacing

The minimum edge distance and spacing of Ancon ESD/ESDQ/ED shear load connectors is determined by the depth of slab and is illustrated in the adjacent drawing. It is possible to reduce the spacing further with the absolute minimum being $1.5 H_{min}$ (where H_{min} is the minimum slab depth for each connector type), however the design resistances are then limited to those given for H_{min} .

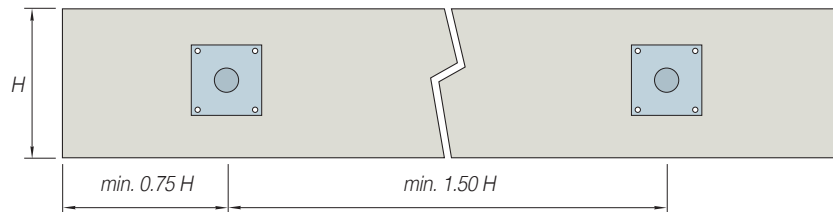

Ancon Staisil-HLD Acoustic Shear Dowel

Dowel Component

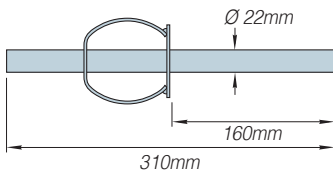

Sleeve

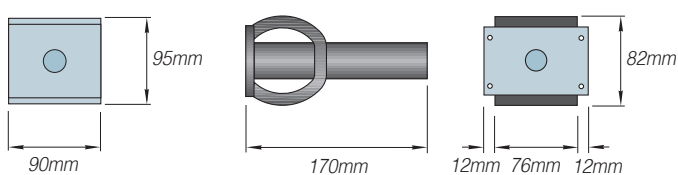

Edge Distance and Spacing

The minimum edge distance and spacing of Ancon Staisil-HLD shear load connectors is determined by the depth of slab and is illustrated in the adjacent drawing. The distances shown apply to slabs less than or equal to 220mm. For slabs greater than 220mm, the minimum spacing is 330mm and the minimum edge distance is 165mm.

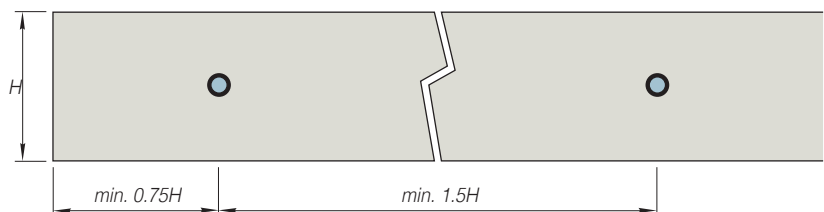

Shear Load Connectors

V_{Rd} Design Resistance (kN) for Various Joint Widths (mm) and Slab Thickness (mm) using 25MPa Concrete

Slab Thickness (mm)	Product Reference	Maximum Width of Joint (mm)			
		10	20	30	40
180*	ESD/ESDQ 10	29.1	25.7	22.4	19.7
200		29.6	25.7	22.4	19.7
220		29.6	25.7	22.4	19.7
240		29.6	25.7	22.4	19.7
260		29.6	25.7	22.4	19.7
280		29.6	25.7	22.4	19.7
180*	ESD/ESDQ 15	32.6	31.9	28.1	24.9
200		36.3	31.9	28.1	24.9
220		36.3	31.9	28.1	24.9
240		36.3	31.9	28.1	24.9
260		36.3	31.9	28.1	24.9
280		36.3	31.9	28.1	24.9
220*	ESD/ESDQ 20	53.6	53.6	53.6	52.7
240		62.2	62.2	57.8	52.7
260		69.9	63.5	57.8	52.7
280		69.9	63.5	57.8	52.7
300		69.9	63.5	57.8	52.7
350		69.9	63.5	57.8	52.7
240*	ESD/ESDQ 25	64.4	64.4	61.5	55.7
260		73.7	68.0	61.5	55.7
280		75.4	68.0	61.5	55.7
300		75.4	68.0	61.5	55.7
350		75.4	68.0	61.5	55.7
400		75.4	68.0	61.5	55.7

Slab Thickness (mm)	Product Reference	Maximum Width of Joint (mm)			
		10	20	30	40
180*	ED 10	14.5	12.8	11.2	9.8
200		14.8	12.8	11.2	9.8
220		14.8	12.8	11.2	9.8
240		14.8	12.8	11.2	9.8
260		14.8	12.8	11.2	9.8
280		14.8	12.8	11.2	9.8
180*	ED 15	16.3	15.9	14.1	12.5
200		18.2	15.9	14.1	12.5
220		18.2	15.9	14.1	12.5
240		18.2	15.9	14.1	12.5
260		18.2	15.9	14.1	12.5
280		18.2	15.9	14.1	12.5
220*	ED 20	26.8	26.8	26.8	26.4
240		31.1	31.1	28.9	26.4
260		35.0	31.8	28.9	26.4
280		35.0	31.8	28.9	26.4
300		35.0	31.8	28.9	26.4
350		35.0	31.8	28.9	26.4
240*	ED 25	32.2	32.2	30.7	27.9
260		36.8	34.0	30.7	27.9
280		37.7	34.0	30.7	27.9
300		37.7	34.0	30.7	27.9
350		37.7	34.0	30.7	27.9
400		37.7	34.0	30.7	27.9

* Refers to the minimum slab depth H_{min} for each connector type.

Slab Thickness (mm)	Product Reference	Maximum Width of Joint (mm)					
		10	20	30	40	50	60
180	Staisil-HLD	35	35	35	34	33	32
200		37	37	37	37	37	37
220		39	39	39	39	39	39
240		39	39	39	39	39	39
260		39	39	39	39	39	39
280		39	39	39	39	39	39
300		39	39	39	39	39	39
320		39	39	39	39	39	39

Position of connectors in slab

The tables on pages 20 and 21 are based on the shear connector being located centrally in the slab edge. If the shear connector is offset from the centreline, the minimum distance between the connector centre and the slab face should be considered as $H/2$.

$$H = 2 \times \min(A, B)$$

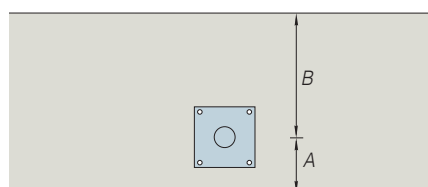

$A < B$
Slab thickness to be considered in selecting the connector is $2 \times A$. Minimum values are shown in the table.

Product Reference	Minimum Slab Depth H_{min}	Minimum Depth 'A'
ESD/ESDQ 10	180mm	90mm
ESD/ESDQ 15	180mm	90mm
ESD/ESDQ 20	220mm	110mm
ESD/ESDQ 25	240mm	120mm
ED 10	180mm	90mm
ED 15	180mm	90mm
ED 20	220mm	110mm
ED 25	240mm	120mm
Staisil-HLD	180mm	90mm

V_{Rd} Design Resistance (kN) for Various Joint Widths (mm) and Slab Thickness (mm) using 32MPa Concrete

Slab Thickness (mm)	Product Reference	Maximum Width of Joint (mm)			
		10	20	30	40
180*	ESD/ESDQ 10	29.1	25.7	22.4	19.7
200		29.6	25.7	22.4	19.7
220		29.6	25.7	22.4	19.7
240		29.6	25.7	22.4	19.7
260		29.6	25.7	22.4	19.7
280		29.6	25.7	22.4	19.7
180*	ESD/ESDQ 15	32.6	31.9	28.1	24.9
200		36.3	31.9	28.1	24.9
220		36.3	31.9	28.1	24.9
240		36.3	31.9	28.1	24.9
260		36.3	31.9	28.1	24.9
280		36.3	31.9	28.1	24.9
220*	ESD/ESDQ 20	53.6	53.6	53.6	52.7
240		62.2	62.2	57.8	52.7
260		69.9	63.5	57.8	52.7
280		69.9	63.5	57.8	52.7
300		69.9	63.5	57.8	52.7
350		69.9	63.5	57.8	52.7
240*	ESD/ESDQ 25	64.4	64.4	61.5	55.7
260		73.7	68.0	61.5	55.7
280		75.4	68.0	61.5	55.7
300		75.4	68.0	61.5	55.7
350		75.4	68.0	61.5	55.7
400		75.4	68.0	61.5	55.7

Slab Thickness (mm)	Product Reference	Maximum Width of Joint (mm)			
		10	20	30	40
180*	ED 10	14.5	12.8	11.2	9.8
200		14.8	12.8	11.2	9.8
220		14.8	12.8	11.2	9.8
240		14.8	12.8	11.2	9.8
260		14.8	12.8	11.2	9.8
280		14.8	12.8	11.2	9.8
180*	ED 15	16.3	15.9	14.1	12.5
200		18.2	15.9	14.1	12.5
220		18.2	15.9	14.1	12.5
240		18.2	15.9	14.1	12.5
260		18.2	15.9	14.1	12.5
280		18.2	15.9	14.1	12.5
220*	ED 20	26.8	26.8	26.8	26.4
240		31.1	31.1	28.9	26.4
260		35.0	31.8	28.9	26.4
280		35.0	31.8	28.9	26.4
300		35.0	31.8	28.9	26.4
350		35.0	31.8	28.9	26.4
240*	ED 25	32.2	32.2	30.7	27.9
260		36.8	34.0	30.7	27.9
280		37.7	34.0	30.7	27.9
300		37.7	34.0	30.7	27.9
350		37.7	34.0	30.7	27.9
400		37.7	34.0	30.7	27.9

* Refers to the minimum slab depth H_{min} for each connector type.

Slab Thickness (mm)	Product Reference	Maximum Width of Joint (mm)					
		10	20	30	40	50	60
180	Staisil-HLD	35	35	35	34	33	32
200		37	37	37	37	37	37
220		39	39	39	39	39	39
240		39	39	39	39	39	39
260		39	39	39	39	39	39
280		39	39	39	39	39	39
300		39	39	39	39	39	39
320		39	39	39	39	39	39

ESD Design Example

Slab thickness = 220mm
 Maximum width of Joint = 30mm
 Concrete Strength = 32MPa
 Characteristic dead load = 20kN/m
 Characteristic imposed load = 26kN/m
 Design load = (20 x 1.2) + (26 x 1.5) = 63kN/m

$\gamma_G = 1.2^*$
 $\gamma_Q = 1.5^*$

F_{Rd} (Design Capacity)
 ESD10 = 22.4kN = 22.4 / 63 = 0.356m use 350mm
 ESD15 = 28.1kN = 28.1 / 63 = 0.446m use 440mm
 ESD20 = 53.6kN = 53.6 / 63 = 0.851m use 850mm

Any of the three connectors would be acceptable, although using ESD20s at 800mm centres would minimise the number of connectors to be installed.

*The partial safety factors of 1.2 (γ_G) and 1.5 (γ_Q) are those recommended in AS 1170 Structural Design Actions.

Shear Load Connectors

ESD Reinforcement Details

Local reinforcement is required around each connector to guarantee that the forces are transferred between the connectors and the concrete. Correct detailing in accordance with appropriate design codes and the recommendations provided here will ensure Ancon ESD, ESDQ, ED and Staisil connectors attain their full capacity.

The tables show proposals for the type and spacing of the main reinforcement, together with details of reinforcement above and below the connectors.

For walls, the reinforcement is repeated as in the tables but with links replacing the U-bars. Links should extend between the near face and the far face of the wall reinforcement.

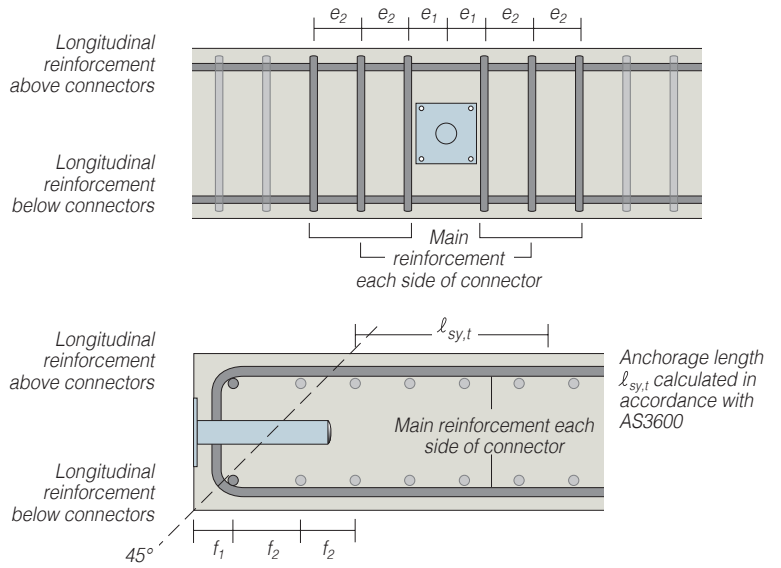

Based on a minimum of 32MPa Concrete, maximum slab depth (see page 21) and 20mm joint, 30mm cover

ED/ESD/ESDQ	Options for Main Reinforcement (No. U bars each side)	
	U bars	Maximum Spacing (mm)
10	2 N10	$e_1 = 35\text{mm}; e_2 = 50\text{mm}$
	1 N12	$e_1 = 35\text{mm}$
15	2 N10	$e_1 = 50\text{mm}; e_2 = 40\text{mm}$
20	2 N12	$e_1 = 40\text{mm}; e_2 = 30\text{mm}$
25	3 N12	$e_1 = 45\text{mm}; e_2 = 45\text{mm}$
Staisil-HLD	2 N10	$e_1 = 35\text{mm}; e_2 = 50\text{mm}$
	1 N12	$e_1 = 35\text{mm}$

ED/ESD/ESDQ	Options for Longitudinal Reinforcement (No. bars top and bottom)	
	U bars	Spacing (mm)
10	2 N10	$f_1 = 60\text{mm}; f_2 = 70\text{mm}$
	1 N12	$f_1 = 60\text{mm}; f_2 = 70\text{mm}$
15	2 N10	$f_1 = 60\text{mm}; f_2 = 70\text{mm}$
	1 N12	$f_1 = 60\text{mm}; f_2 = 70\text{mm}$
20	2 N10	$f_1 = 60\text{mm}; f_2 = 70\text{mm}$
	1 N12	$f_1 = 60\text{mm}; f_2 = 70\text{mm}$
25	2 N10	$f_1 = 60\text{mm}; f_2 = 70\text{mm}$
Staisil-HLD	2 N10	$f_1 = 60\text{mm}; f_2 = 70\text{mm}$
	1 N12	$f_1 = 60\text{mm}; f_2 = 70\text{mm}$

Cover

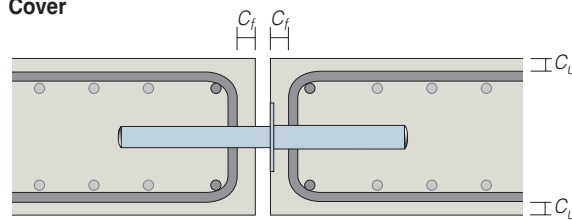

Minimum cover C_u to local reinforcement is the recommendations of AS3600

Reference	Minimum Cover to Face C_f	Maximum Cover to Face C_f
10		50mm
15	To be specified by engineer according to AS3600	50mm
20		50mm
25		50mm
Staisil-HLD		50mm

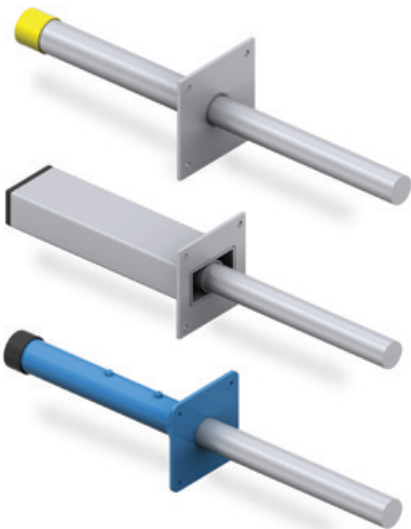
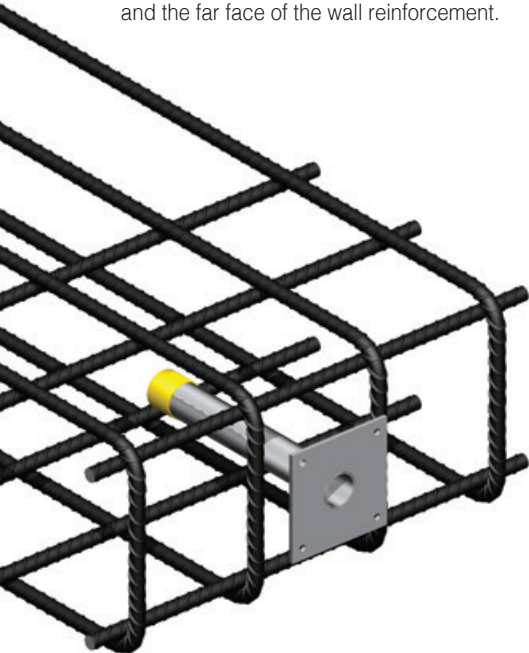

Fire Protection

Ancon shear connectors can be provided with a fire rating of 120 mins (REI 120) as per EN 13501-2. Special sleeves, manufactured from a fire barrier material, replace the compressible filler at the connector's position in the joint. This material foams and expands during a fire to protect the connector.

Fire protection sleeves are supplied in a thickness of 20 and 30mm to fit the respective joint thickness. Sleeves of different thicknesses can be used together for larger joints. The hole or holes in the sleeve are supplied to suit the connector's dowel diameter.

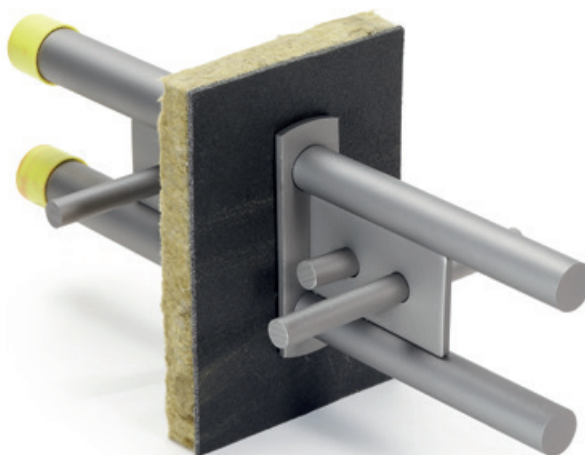

Product Codes

Connector/Fire Protection Sleeve/Thickness
e.g DSD30/FPS/20, ESDQ/FPS/30

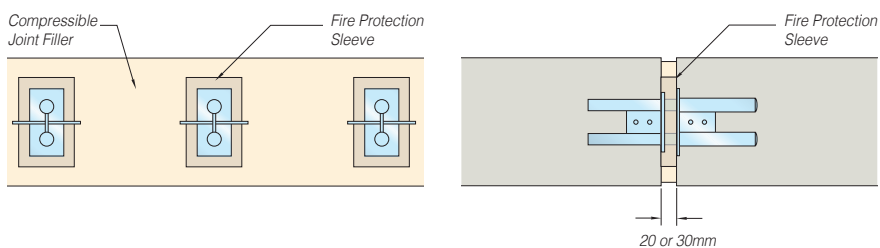

DSDQ Sleeve

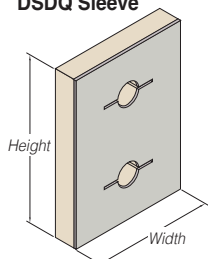

ESDQ Sleeve

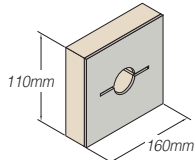

Available thicknesses: 20mm, 30mm

Dimensions

Part No.	Width/Height (mm)
DSD25/FPS/20	110/160
DSD30/FPS/20	110/160
DSD50/FPS/20	110/160
DSD65/FPS/20	110/160
DSD75/FPS/20	110/160
DSD100/FPS/20	170/250
DSD130/FPS/20	170/250
DSD150/FPS/20	170/250
DSD400/FPS/20	300/350
DSD450/FPS/20	300/350

For 30mm thickness please replace 20 with 30. For Fire Protection Sleeves for ESD, please replace DSD with ESD in the part number.

The Fire Protection Sleeves always suit both, DSD/ESD and DSDQ/ESDQ types.

Shear Load Connectors

Lockable Dowels

Ancon Lockable Dowels (Australian Patent 2008294503) are most commonly used at temporary building joints in post-tensioned floors. The dowel allows initial shrinkage of the concrete to take place and is then locked in position with an epoxy resin, inserted from the top of the slab.

They are a proven, independently-tested solution which is both easy to detail and install on site. The range comprises three products; ESDQ-L20 and HLDQ-L30 for slab-to-slab applications, and ESDQ-L20W for slab-to-wall applications.

More information is in the Ancon Lockable Dowel brochure.

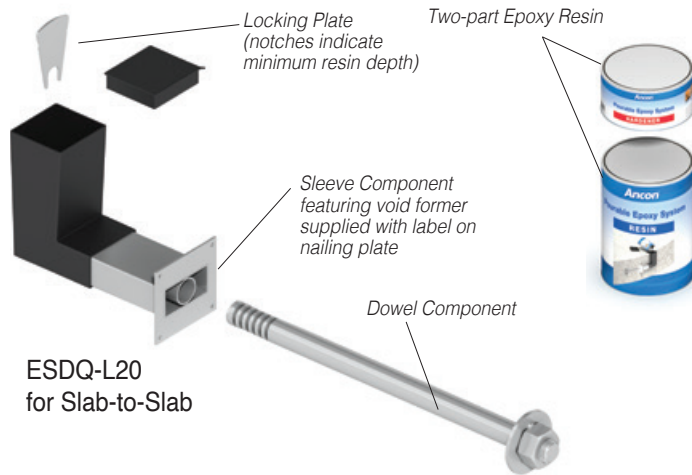

ESDQ-L20
for Slab-to-Slab

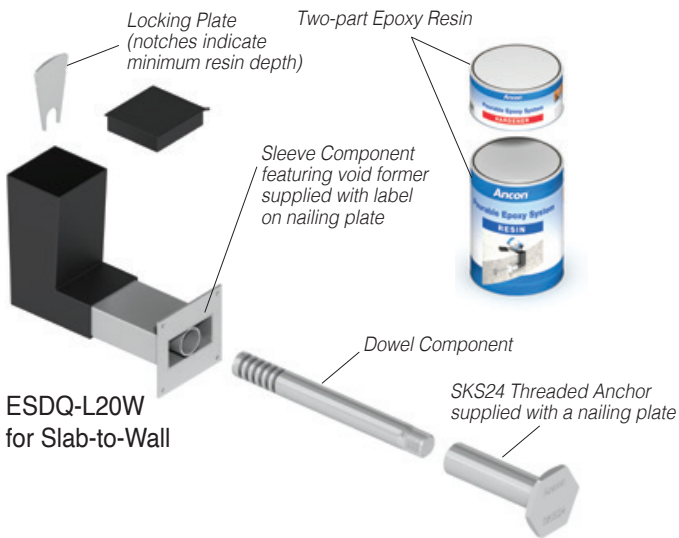

ESDQ-L20W
for Slab-to-Wall

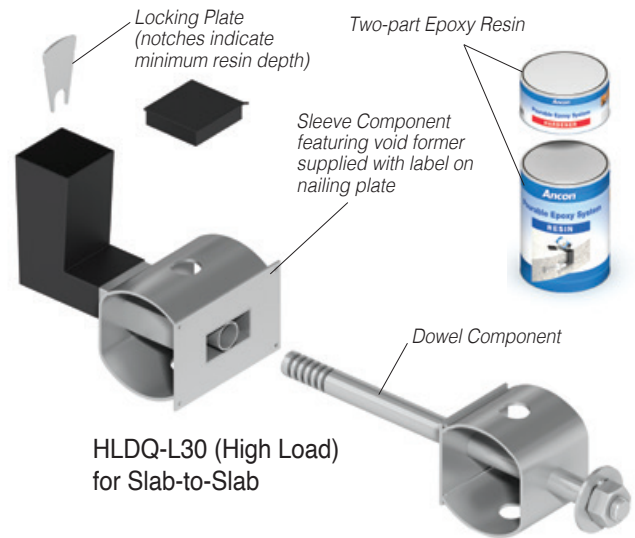

HLDQ-L30 (High Load)
for Slab-to-Slab

Slab-to-Slab

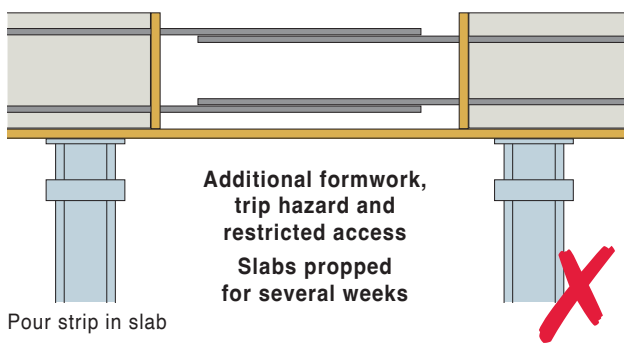

Pour strip in slab

**Additional formwork,
trip hazard and
restricted access
Slabs propped
for several weeks**

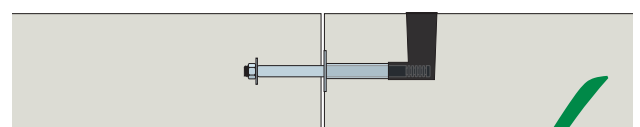

Ancon Lockable Dowel

**Minimal formwork
Improved site access
Reduced propping time**

Slab-to-Wall

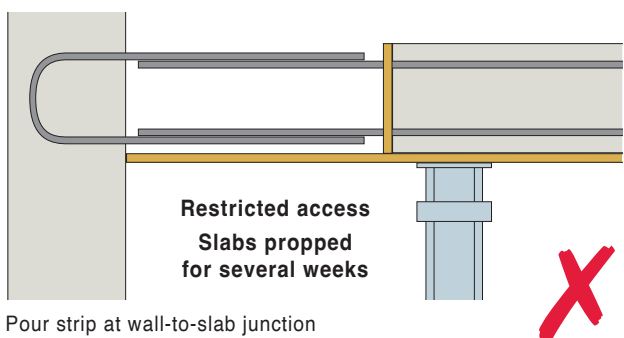

Pour strip at wall-to-slab junction

**Restricted access
Slabs propped
for several weeks**

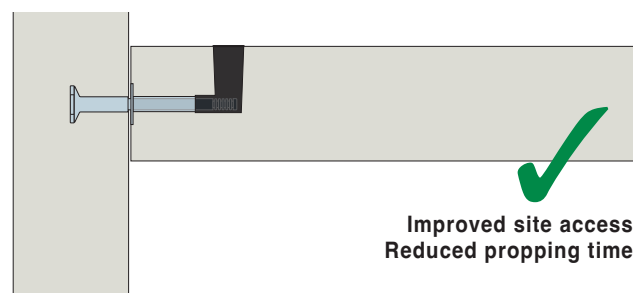

Ancon Lockable Dowel

**Improved site access
Reduced propping time**

Projects



Victoria Point, Melbourne, VIC



Riparian Plaza, Brisbane, QLD



Casino Towers, Brisbane, QLD



Melbourne Cricket Ground, VIC

Other Ancon Products

Punching Shear Reinforcement

Ancon Shearfix is used within a slab to provide additional reinforcement from punching shear around columns. The system consists of double-headed steel studs welded to flat rails and is designed to suit the load conditions and slab depth at each column using our free calculation software.

Reinforcing Bar Couplers

The use of reinforcing bar couplers can provide significant advantages over lapped joints. Design and construction of the concrete can be simplified and the amount of reinforcement can be reduced. The Ancon range includes BT parallel-threaded and MBT mechanically-bolted couplers.

Reinforcement Continuity Systems

Reinforcement Continuity Systems are an increasingly popular means of maintaining continuity of reinforcement at construction joints in concrete. The Ancon Keybox system eliminates the need to drill shuttering and can simplify formwork design, thereby accelerating the construction process. It is available in both standard units and special configurations. Ancon KSN Anchors eliminate the need for on-site bar straightening and are available to accept reinforcement of 12mm, 16mm and 20mm diameter. The system is also available with a re-useable rebate former.

Stainless Steel Reinforcement

Leviat supplies stainless steel plain and ribbed bar in a variety of grades, including high proof strength material. Bar diameters range from 6mm to 50mm and can be cut to length, bent and threaded to suit any application. Stainless steel BT couplers are also available to suit bars from 12mm diameter.

Special Fabrications

Leviat is an ASSDA accredited specialist fabricator and has a wealth of experience in working with a variety of material grades. High integrity steel components are supplied to a wide range of industries including Civil Engineering, Building, Infrastructure, Water Treatment, Nuclear and Mining.

Precast Concrete Accessories

Leviat offers an unrivalled service to the precast concrete industry. Our technical and sales support services, extensive product range and nationwide operations, enable us to provide a customer focused service that is second to none. Our product portfolio of lifting, fixing and anchoring technologies includes European-engineered systems and market leading brands.



© Thiess, Energy Australia



Worldwide contacts for Leviat:

Australia

Leviat

98 Kurrajong Avenue,
Mount Druitt Sydney, NSW 2770
Tel: +61 - 2 8808 3100
Email: info.au@leviat.com

Austria

Leviat

Leonard-Bernstein-Str. 10
Saturn Tower, 1220 Wien
Tel: +43 - 1 - 259 6770
Email: info.at@leviat.com

Belgium

Leviat

Industrielaan 2
1740 Ternat
Tel: +32 - 2 - 582 29 45
Email: info.be@leviat.com

China

Leviat

Room 601 Tower D, Vantone Centre
No. A6 Chao Yang Men Wai Street
Chaoyang District
Beijing · P.R. China 100020
Tel: +86 - 10 5907 3200
Email: info.cn@leviat.com

Czech Republic

Leviat

Business Center Šafránková
Šafránková 1238/1
155 00 Praha 5
Tel: +420 - 311 - 690 060
Email: info.cz@leviat.com

Finland

Leviat

Vädursgatan 5
412 50 Göteborg / Sweden
Tel: +358 (0)10 6338781
Email: info.fi@leviat.com

France

Leviat

6, Rue de Cabanis
FR 31240 L'Union
Toulouse
Tel: +33 - 5 - 34 25 54 82
Email: info.fr@leviat.com

Germany

Leviat

Liebigstrasse 14
40764 Langenfeld
Tel: +49 - 2173 - 970 - 0
Email: info.de@leviat.com

India

Leviat

309, 3rd Floor, Orion Business Park
Ghodbunder Road, Kapurbawdi, Thane
West, Thane,
Maharashtra 400607
Tel: +91 - 22 2589 2032
Email: info.in@leviat.com

Italy

Leviat

Via F.lli Bronzetti 28
24124 Bergamo
Tel: +39 - 035 - 0760711
Email: info.it@leviat.com

Malaysia

Leviat

28 Jalan Anggerik Mokara 31/59
Kota Kemuning, 40460 Shah Alam
Selangor
Tel: +603 - 5122 4182
Email: info.my@leviat.com

Netherlands

Leviat

Oostermaat 3
7623 CS Borne
Tel: +31 - 74 - 267 14 49
Email: info.nl@leviat.com

New Zealand

Leviat

2/19 Nuttall Drive, Hillsborough,
Christchurch 8022
Tel: +64 - 3 376 5205
Email: info.nz@leviat.com

Norway

Leviat

Vestre Svanholmen 5
4313 Sandnes
Tel: +47 - 51 82 34 00
Email: info.no@leviat.com

Philippines

Leviat

2933 Regus, Joy Nostalg,
ADB Avenue
Ortigas Center
Pasig City
Tel: +63 - 2 7957 6381
Email: info.ph@leviat.com

Poland

Leviat

Ul. Obornicka 287
60-691 Poznań
Tel: +48 - 61 - 622 14 14
Email: info.pl@leviat.com

Singapore

Leviat

14 Benoi Crescent
Singapore 629977
Tel: +65 - 6266 6802
Email: info.sg@leviat.com

Spain

Leviat

Polígono Industrial Santa Ana
c/ Ignacio Zuloaga, 20
28522 Rivas-Vaciamadrid
Tel: +34 - 91 632 18 40
Email: info.es@leviat.com

Sweden

Leviat

Vädursgatan 5
412 50 Göteborg
Tel: +46 - 31 - 98 58 00
Email: info.se@leviat.com

Switzerland

Leviat

Grenzstrasse 24
3250 Lyss
Tel: +41 - 31 750 3030
Email: info.ch@leviat.com

United Arab Emirates

Leviat

RA08 TB02, PO Box 17225
JAFZA, Jebel Ali, Dubai
Tel: +971 (0)4 883 4346
Email: info.ae@leviat.com

United Kingdom

Leviat

President Way, President Park,
Sheffield, S4 7UR
Tel: +44 - 114 275 5224
Email: info.uk@leviat.com

United States of America

Leviat

6467 S Falkenburg Rd.
Riverview, FL 33578
Tel: (800) 423-9140
Email: info.us@leviat.us

For countries not listed

Email: info@leviat.com

Leviat.com

Notes regarding this catalogue

© Protected by copyright. The construction applications and details provided in this publication are indicative only. In every case, project working details should be entrusted to appropriately qualified and experienced persons. Whilst every care has been exercised in the preparation of this publication to ensure that any advice, recommendations or information is accurate, no liability or responsibility of any kind is accepted by Leviat for inaccuracies or printing errors. Technical and design changes are reserved. With a policy of continuous product development, Leviat reserves the right to modify product design and specification at any time.

For more information on the following products, please contact:

Masonry, Structural and Precast Concrete products:

1300 304 320
info.ancon.au@leviat.com
Ancon.com.au

Concrete Floor Jointing products:

1800 335 215
info.connolly.au@leviat.com
Connollykeyjoint.com
info.isedio.au@leviat.com
Isedio.com.au

Remedial Masonry products:

1300 667 071
info.helifix.au@leviat.com
Helifix.com.au

General Enquiries

1300 304 320
Leviat.com

Sales Offices and Production

New South Wales, Sydney

98 Kurrajong Avenue
Mount Druitt | Sydney
NSW 2770

New South Wales, Casino

10 Irving Drive
Casino
NSW 2470

Victoria

9/63-69 Pipe Road
Laverton North | Melbourne
VIC 3026

Queensland

4/15 Terrace Place
Murarrie | Brisbane
QLD 4172

Western Australia

18 Tennant Street
Welshpool | Perth
WA 6106

Leviat.com

Leviat[®]
A CRH COMPANY

Imagine. Model. Make.

Leviat.com